

Professional Video Monitor

Operating Instructions

Before operating the unit, please read this manual thoroughly and retain it for future reference.

BVM-X300

Software Version 2.3

TRIMASTER EL 4K HDMI

Owner's Record

The model and serial numbers are located at the rear. Record these numbers in the spaces provided below. Refer to these numbers whenever you call upon your Sony dealer regarding this product.

Model No. _____
Serial No. _____

Important Safety Instructions

- Read these instructions.
- Keep these instructions.
- Heed all warnings.
- Follow all instructions.
- Do not use this apparatus near water.
- Clean only with dry cloth.
- Do not block any ventilation openings. Install in accordance with the manufacturer's instructions.
- Do not install near any heat sources such as radiators, heat registers, stoves, or other apparatus (including amplifiers) that produce heat.
- Do not defeat the safety purpose of the polarized or grounding-type plug. A polarized plug has two blades with one wider than the other. A grounding-type plug has two blades and a third grounding prong. The wide blade or the third prong are provided for your safety. If the provided plug does not fit into your outlet, consult an electrician for replacement of the obsolete outlet.
- Protect the power cord from being walked on or pinched particularly at plugs, convenience receptacles, and the point where they exit from the apparatus.
- Only use attachments/accessories specified by the manufacturer.
- Use only with the cart, stand, tripod, bracket, or table specified by the manufacturer, or sold with the apparatus.  When a cart is used, use caution when moving the cart/apparatus combination to avoid injury from tip-over.
- Unplug this apparatus during lightning storms or when unused for long periods of time.
- Refer all servicing to qualified service personnel. Servicing is required when the apparatus has been damaged in any way, such as power-supply cord or plug is damaged, liquid has been spilled or objects have fallen into the apparatus, the apparatus has been exposed to rain or moisture, does not operate normally, or has been dropped.

WARNING

To reduce the risk of fire or electric shock, do not expose this apparatus to rain or moisture.

To avoid electrical shock, do not open the cabinet. Refer servicing to qualified personnel only.

THIS APPARATUS MUST BE EARTHED.

WARNING

When installing the unit, incorporate a readily accessible disconnect device in the fixed wiring, or connect the power plug to an easily accessible socket-outlet near the unit. If a fault should occur during operation of the unit, operate the disconnect device to switch the power supply off, or disconnect the power plug.



This symbol is intended to alert the user to the presence of uninsulated "dangerous voltage" within the product's enclosure that may be of sufficient magnitude to constitute a risk of electric shock to persons.



This symbol is intended to alert the user to the presence of important operating and maintenance (servicing) instructions in the literature accompanying the appliance.

CAUTION

The apparatus shall not be exposed to dripping or splashing. No objects filled with liquids, such as vases, shall be placed on the apparatus.

CAUTION

The unit is not disconnected from the AC power source (mains) as long as it is connected to the wall outlet, even if the unit itself has been turned off.

WARNING

Excessive sound pressure from earphones and headphones can cause hearing loss. In order to use this product safely, avoid prolonged listening at excessive sound pressure levels.

When installing the installation space must be secured in consideration of the ventilation and service operation.

- Do not block the ventilation slots, and vents of the fans.
- Leave a space around the unit for ventilation.
- Leave more than 40 cm of space in the rear of the unit to secure the operation area.

When the unit is installed on the desk or the like, leave at least 10 cm of space in the top side.

WARNING: THIS WARNING IS APPLICABLE FOR USA ONLY.

If used in USA, use the UL LISTED power cord specified below.

DO NOT USE ANY OTHER POWER CORD.

Plug Cap	Parallel blade with ground pin (NEMA 5-15P Configuration)
Cord	Type SJT or SVT, three 16 or 18 AWG wires
Length	Minimum 1.5 m (4 ft 11 in), Less than 2.5 m (8 ft 3 in)
Rating	Minimum 10A, 125V

Using this unit at a voltage other than 120V may require the use of a different line cord or attachment plug, or both. To reduce the risk of fire or electric shock, refer servicing to qualified service personnel.

WARNING: THIS WARNING IS APPLICABLE FOR OTHER COUNTRIES.

1. Use the approved Power Cord (3-core mains lead) / Appliance Connector / Plug with earthing-contacts that conforms to the safety regulations of each country if applicable.
2. Use the Power Cord (3-core mains lead) / Appliance Connector / Plug conforming to the proper ratings (Voltage, Ampere).

If you have questions on the use of the above Power Cord / Appliance Connector / Plug, please consult a qualified service personnel.

For the customers in the U.S.A.

This equipment has been tested and found to comply with the limits for a Class A digital device, pursuant to part 15 of the FCC Rules. These limits are designed to provide reasonable protection against harmful interference when the equipment is operated in a commercial environment. This equipment generates, uses, and can radiate radio frequency energy and, if not installed and used in accordance with the instruction manual, may cause harmful interference to radio communications. Operation of this equipment in a residential area is likely to cause harmful interference in which case the user will be required to correct the interference at his own expense.

You are cautioned that any changes or modifications not expressly approved in this manual could void your authority to operate this equipment.

All interface cables used to connect peripherals must be shielded in order to comply with the limits for a digital device pursuant to Subpart B of part 15 of FCC Rules.

This device complies with part 15 of the FCC Rules. Operation is subject to the following two conditions: (1) This device may not cause harmful interference, and (2) this device must accept any interference received, including interference that may cause undesired operation.

For the customers in Canada

CAN ICES-3 (A)/NMB-3(A)

For the customers in Europe

This product with the CE marking complies with the EMC Directive issued by the Commission of the European Community.

Compliance with this directive implies conformity to the following European standards:

- EN55103-1 : Electromagnetic Interference(Emission)
- EN55103-2 : Electromagnetic Susceptibility(Immunity)

This product is intended for use in the following Electromagnetic Environment: E4 (controlled EMC environment, ex. TV studio).

This apparatus shall not be used in the residential area.

For the customers in Europe, Australia and New Zealand

WARNING

This is a Class A product. In a domestic environment, this product may cause radio interference in which case the user may be required to take adequate measures.

Disposal of Old Electrical & Electronic Equipment (Applicable in Republic of India)



This symbol indicates that this product and its components, consumables, parts or spares thereof shall not be treated as household waste and may not be dropped in garbage bins. Product owners are advised to deposit their product at the nearest collection point for the recycling of electrical and electronic equipment. Your co-operation shall facilitate proper disposal & help prevent potential negative consequences/hazards to the environment and human health, which could otherwise be caused by inappropriate waste disposal including improper handling, accidental breakage, damage and/ or improper recycling of e-waste. The recycling of materials will help to conserve natural resources. For more detailed information about recycling of this product, please contact your local civic office, your household waste disposal service provider or the store where you

made the purchase. You may contact our company's toll free number in India for assistance.

Toll Free: 1800-103-7799

Visit: www.sony.co.in for product recycling

Reduction in the Use of Hazardous Substances in Electrical & Electronic Equipment (Applicable in Republic of India)

This product and its components, consumables, parts or spares comply with the hazardous substances restriction of India's E-Waste (Management) Rules. The maximum allowable concentrations of the restricted substances are 0.1% by weight in homogenous materials for Lead, Mercury, Hexavalent Chromium, Polybrominated Biphenyls (PBB) and Polybrominated Diphenyl Ethers (PBDE), and 0.01% by weight in homogenous materials for Cadmium, except for the exemptions specified in Schedule II of the aforesaid Rules.

For the customers in the U.S.A.

SONY LIMITED WARRANTY - Please visit <http://www.sony.com/psa/warranty> for important information and complete terms and conditions of Sony's limited warranty applicable to this product.

For the customers in Canada

SONY LIMITED WARRANTY - Please visit <http://www.sonybiz.ca/pro/lang/en/ca/article/resources-warranty> for important information and complete terms and conditions of Sony's limited warranty applicable to this product.

For the customers in Europe

Sony Professional Solutions Europe - Standard Warranty and Exceptions on Standard Warranty. Please visit https://pro.sony/en_GB/support-services/warranty/support-professional-solutions-europe-standard-product-warranty for important information and complete terms and conditions.

For the customers in Korea

SONY LIMITED WARRANTY - Please visit <http://bpeng.sony.co.kr/handler/BPAS-Start> for important information and complete terms and conditions of Sony's limited warranty applicable to this product.

Consignes de sécurité importantes

- Lisez ces instructions.
- Conservez ces instructions.
- Tenez compte de tous les avertissements.
- Suivez toutes les instructions.
- N'utilisez pas cet appareil à proximité d'eau.
- Nettoyez cet appareil uniquement avec un chiffon sec.

- Ne bloquez aucun orifice de ventilation. Installez cet appareil conformément aux instructions du fabricant.
- Ne l'installez pas à proximité de sources de chaleur comme des radiateurs, des registres de chaleur, des poêles ou d'autres appareils (y compris des amplificateurs) produisant de la chaleur.
- Ne désactivez pas le dispositif de sécurité de la fiche polarisée ou avec mise à la terre. Une fiche polarisée possède deux lames dont l'une est plus large que l'autre. Une fiche avec mise à la terre possède deux lames et une troisième broche de mise à la terre. La lame la plus large et la troisième broche sont fournies pour votre sécurité. Si la fiche fournie ne rentre pas dans votre prise de courant, consultez un électricien afin qu'il remplace la prise obsolète.
- Protégez le cordon d'alimentation afin que personne ne marche dessus et qu'il ne se coince pas, en particulier au niveau de la fiche, de la prise de courant et à l'endroit où il sort de l'appareil.
- N'utilisez que les fixations et accessoires indiqués par le fabricant.
- Utilisez l'appareil uniquement avec le chariot, le support, le trépied ou la table indiqué par le fabricant ou vendu avec l'appareil. Lorsque vous utilisez un chariot, faites attention lorsque vous déplacez le chariot et l'appareil ensemble afin d'éviter de vous blesser en cas de chute.
- Débranchez cet appareil en cas d'orage ou lorsqu'il n'est pas utilisé pendant de longues périodes.
- Faites appel à un technicien qualifié pour toute réparation/entretien. L'entretien/réparation est nécessaire lorsque l'appareil a été endommagé de quelque façon que ce soit, par exemple si le cordon ou la fiche d'alimentation a été endommagé, si du liquide a été renversé ou si des objets sont tombés dans l'appareil, si l'appareil a été exposé à la pluie ou à l'humidité, s'il ne fonctionne pas normalement ou s'il a subi une chute.



AVERTISSEMENT

Afin de réduire les risques d'incendie ou d'électrocution, ne pas exposer cet appareil à la pluie ou à l'humidité.

Afin d'écartier tout risque d'électrocution, garder le coffret fermé. Ne confier l'entretien de l'appareil qu'à un personnel qualifié.

CET APPAREIL DOIT ÊTRE RELIÉ À LA TERRE.

AVERTISSEMENT

Lors de l'installation de l'appareil, incorporer un dispositif de coupure dans le câblage fixe ou brancher la fiche d'alimentation dans une prise murale facilement accessible proche de l'appareil. En cas de problème lors

du fonctionnement de l'appareil, enclencher le dispositif de coupure d'alimentation ou débrancher la fiche d'alimentation.



Ce symbole est destiné à avertir l'utilisateur de la présence d'une « tension dangereuse » non isolée dans l'enveloppe du produit, qui pourrait être suffisamment importante pour représenter un risque d'électrocution pour les personnes.



Ce symbole est destiné à avertir l'utilisateur de la présence d'instructions d'utilisation et de maintenance (entretien/réparation) importantes dans la documentation accompagnant l'appareil.

ATTENTION

Eviter d'exposer l'appareil à un égouttement ou à des éclaboussures. Ne placer aucun objet rempli de liquide, comme un vase, sur l'appareil.

ATTENTION

Cet appareil n'est pas déconnecté de la source d'alimentation secteur tant qu'il est raccordé à la prise murale, même si l'appareil lui-même a été mis hors tension.

AVERTISSEMENT

Une pression acoustique excessive en provenance des écouteurs ou du casque peut provoquer une baisse de l'acuité auditive.

Pour utiliser ce produit en toute sécurité, évitez l'écoute prolongée à des pressions sonores excessives.

AVERTISSEMENT :CET AVERTISSEMENT S'APPLIQUE AUX ÉTATS-UNIS UNIQUEMENT.
En cas d'utilisation aux États-Unis, utilisez le cordon d'alimentation RÉPERTORIÉ UL indiqué ci-dessous. N'UTILISEZ AUCUN AUTRE CORDON D'ALIMENTATION.

Bouchon de fiche	Lame parallèle avec broche de terre (configuration NEMA 5-15P)
Cordon	Type SJT ou SVT, trois fils 16 ou 18 AWG
Longueur	Minimum 1,5 m (4 pieds 11 pouces), moins de 2,5 m (8 pieds 3 pouces)
Caractéristiques nominales	Minimum 10 A, 125 V

L'utilisation de cet appareil à une tension autre que 120 V peut nécessiter l'utilisation d'un type différent de cordon ou de fiche de fixation, ou les deux. Afin de réduire les risques d'incendie ou d'électrocution, faites appel à un technicien qualifié pour toute réparation/entretien.

AVERTISSEMENT : CET AVERTISSEMENT S'APPLIQUE AUX AUTRES PAYS.

1. Utilisez un cordon d'alimentation (câble secteur à 3 fils)/fiche femelle/fiche mâle avec des contacts de mise à la terre conformes à la réglementation de sécurité locale applicable.
2. Utilisez un cordon d'alimentation (câble secteur à 3 fils)/fiche femelle/fiche mâle avec des caractéristiques nominales (tension, ampérage) appropriées.

Pour toute question sur l'utilisation du cordon d'alimentation/fiche femelle/fiche mâle ci-dessus, consultez un technicien du service après-vente qualifié.

Pour les clients au Canada

CAN ICES-3 (A)/NMB-3(A)

Pour les clients en Europe

Ce produit portant la marque CE est conforme à la Directive sur la compatibilité électromagnétique (EMC) émise par la Commission de la Communauté européenne.

La conformité à cette directive implique la conformité aux normes européennes suivantes:

- EN55103-1: Interférences électromagnétiques (émission)
- EN55103-2: Sensibilité électromagnétique (immunité)

Ce produit est prévu pour être utilisé dans l'environnement électromagnétique suivant: E4 (environnement EMC contrôlé, ex. studio de télévision).

Ne pas utiliser cet appareil dans une zone résidentielle.

Pour les clients en Europe, Australie et Nouvelle-Zélande

AVERTISSEMENT

Il s'agit d'un produit de Classe A. Dans un environnement domestique, cet appareil peut provoquer des interférences radio, dans ce cas l'utilisateur peut être amené à prendre des mesures appropriées.

Pour les clients au Canada

GARANTIE LIMITÉE DE SONY - Rendez-vous sur <http://www.sonybiz.ca/pro/lang/en/ca/article/resources-warranty> pour obtenir les informations importantes et l'ensemble des termes et conditions de la garantie limitée de Sony applicable à ce produit.

WARNUNG

Um die Gefahr von Bränden oder elektrischen Schlägen zu verringern, darf dieses Gerät nicht Regen oder Feuchtigkeit ausgesetzt werden.

Um einen elektrischen Schlag zu vermeiden, darf das Gehäuse nicht geöffnet werden. Überlassen Sie Wartungsarbeiten stets nur qualifiziertem Fachpersonal.

DIESES GERÄT MUSS GEERDET WERDEN.

WARNUNG

Beim Einbau des Geräts ist daher im Festkabel ein leicht zugänglicher Unterbrecher einzufügen, oder der Netzstecker muss mit einer in der Nähe des Geräts befindlichen, leicht zugänglichen Wandsteckdose verbunden werden. Wenn während des Betriebs eine Funktionsstörung auftritt, ist der Unterbrecher zu betätigen bzw. der Netzstecker abzuziehen, damit die Stromversorgung zum Gerät unterbrochen wird.

VORSICHT

Das Gerät ist nicht tropf- und spritzwassergeschützt. Es dürfen keine mit Flüssigkeiten gefüllten Gegenstände, z. B. Vasen, darauf abgestellt werden.

VORSICHT

Solange das Netzkabel an eine Netzsteckdose angeschlossen ist, bleibt das Gerät auch im ausgeschalteten Zustand mit dem Stromnetz verbunden.

WARNUNG

Zu hoher Schalldruck von Ohrhörern und Kopfhörern kann Gehörschäden verursachen. Um dieses Produkt sicher zu verwenden, vermeiden Sie längeres Hören bei sehr hohen Schalldruckpegeln.

WARNUNG

1. Verwenden Sie ein geprüftes Netzkabel (3-adriges Stromkabel)/einen geprüften Geräteanschluss/einen geprüften Stecker mit Schutzkontakten entsprechend den Sicherheitsvorschriften, die im betreffenden Land gelten.
2. Verwenden Sie ein Netzkabel (3-adriges Stromkabel)/einen Geräteanschluss/einen Stecker mit den geeigneten Anschlusswerten (Volt, Ampere).

Wenn Sie Fragen zur Verwendung von Netzkabel/ Geräteanschluss/Stecker haben, wenden Sie sich bitte an qualifiziertes Kundendienstpersonal.

Für Kunden in Europa

Dieses Produkt besitzt die CE-Kennzeichnung und erfüllt die EMV-Richtlinie der EG-Kommission.

Angewandte Normen:

- EN55103-1: Elektromagnetische Verträglichkeit (Störaussendung)

- EN55103-2: Elektromagnetische Verträglichkeit (Störfestigkeit)

Für die folgende elektromagnetische Umgebung: E4 (kontrollierter EMV-Bereich, z.B. Fernsehstudio).

Dieser Apparat darf nicht im Wohnbereich verwendet werden.

Für Kunden in Europa, Australien und Neuseeland WARNUNG

Dies ist eine Einrichtung, welche die Funk-Entstörung nach Klasse A besitzt. Diese Einrichtung kann im Wohnbereich Funkstörungen verursachen; in diesem Fall kann vom Betreiber verlangt werden, angemessene Maßnahmen durchzuführen und dafür aufzukommen.

For kundene i Norge

Dette utstyret kan kobles til et IT-strømfordelingssystem.

Apparatet må tilkoples jordet stikkontakt

Suomessa asuville asiakkaille

Laite on liitettävä suojamaadoituskoskettimilla varustettuun pistorasiaan

För kunderna i Sverige

Apparaten skall anslutas till jordat uttag

A급 기기(업무용 방송통신기자재)

이 기기는 업무용(A급) 전자파적합기기로서 판매자 또는 사용자는 이 점을 주의하시기 바라며, 가정 외의 지역에서 사용하는 것을 목적으로 합니다.

주소: 서울시 영등포구 영등포동 2가 28-130 가야벤
처빌딩 2층 소니코리아
전화번호: 02-782-3560
팩스번호: 02-782-4466

콜센터: 02-1588-7313

웹사이트 주소: <http://bpeng.sony.co.kr/>
<http://bp.sony.co.kr/>

Türkiye'deki müşteriler için AEEE Yönetmeliğine Uygundur

Table of Contents

Precaution	8
On Safety	8
On Installation	8
Connecting to Other Devices	8
Handling the Screen	8
On High Brightness Display	8
On Burn-in	8
On a Long Period of Use	9
On the Surface of the Unit	9
On Long Periods of Continuous Use	9
Handling and Maintenance of the Screen	9
On Dew Condensation	9
On Repacking	10
Transportation of the Unit	10
Disposal of the Unit	10
On Fan Error	10
On the Software Update	10
Location and Function of Parts and Controls	11
Front Panel.....	11
Input Signals and Adjustable/Setting Items	14
Rear Panel.....	15
Connecting the AC Power Cord	16
Connecting the HDMI cable	17
Using the Menu	17
Protection of the Setting Values	18
Protecting the setting values using the KEY INHIBIT button	18
Protecting the setting values using [Password Lock]	18
Adjustment Using the Menus	19
Items	19
Adjusting and Changing the Settings	19
[Status] menu	19
[User Preset Setting] menu	20
[Color Temp.] menu	21
[User Configuration] menu	22
[Serial Remote] menu	36
[Security] menu	36
Connecting the SDI Signals	37
Troubleshooting	38
Specifications	38
Available Signal Formats.....	39
Dimensions	49

The terms HDMI and HDMI High-Definition Multimedia Interface, and the HDMI Logo are trademarks or registered trademarks of HDMI Licensing Administrator, Inc. in the United States and other countries.

Precaution

On Safety

- Operate the unit only with a power source as specified in the “Specifications” section.
- A nameplate indicating operating voltage, etc., is located on the rear panel.
- Should any solid object or liquid fall into the cabinet, unplug the unit and have it checked by qualified personnel before operating it any further.
- Do not drop or place heavy objects on the power cord. If the power cord is damaged, turn off the power immediately. It is dangerous to use the unit with a damaged power cord.
- Unplug the unit from the wall outlet if it is not to be used for several days or more.
- Disconnect the power cord from the AC outlet by grasping the plug, not by pulling the cord.
- The socket-outlet shall be installed near the equipment and shall be easily accessible.

On Installation

- Allow adequate air circulation to prevent internal heat build-up.
Do not place the unit on surfaces (rugs, blankets, etc.) or near materials (curtains, draperies) that may block the ventilation holes.
- Do not install the unit in a location near heat sources such as radiators or air ducts, or in a place subject to direct sunlight, excessive dust, mechanical vibration or shock.

When installing the installation space must be secured in consideration of the ventilation and service operation.

- Do not block the ventilation slots, and vents of the fans.
- Leave a space around the unit for ventilation.
- Leave more than 40 cm of space in the rear of the unit to secure the operation area.

When the unit is installed on the desk or the like, leave at least 10 cm of space in the top side.

Connecting to Other Devices

When connecting this unit to other devices, turn off this unit and the other devices beforehand. Connecting while turned on may cause a malfunction to this unit and the other devices.

Handling the Screen

- The OLED panel fitted to this unit is manufactured with high precision technology, giving a functioning pixel ratio of at least 99.99%. Thus a very small proportion of pixels may be “stuck”, either always off (black), always on (red, green, or blue), or flashing. In addition, over a long period of use, because of the physical characteristics of the organic light-emitting diode, such “stuck” pixels may appear spontaneously. These problems are not a malfunction.
- Do not leave the screen facing the sun as it can damage the screen. Take care when you place the unit by a window.
- Do not push or scratch the monitor’s screen. Do not place a heavy object on the monitor’s screen. This may cause the screen to lose uniformity.
- The screen and the cabinet become warm during operation. This is not a malfunction.

On High Brightness Display

- Using the unit with the high brightness display for extended periods may cause eyestrain or reduction of eyesight. Be sure to take an occasional break when using.
- Follow RECOMMENDATION ITU-R BT.1702 “Guidance for the reduction of photosensitive epileptic seizures caused by television” or other guidelines when using.
- In the HDR display, the display surface may emit heat when high brightness images are output. Do not touch the surface.
- When [2.4(HDR)], [S-Log3(HDR)], [S-Log2(HDR)], [SMPTE ST 2084(HDR)], [RGB(SG1.2)], [ITU-R BT.2100(HLG)], or [S-Log3(Live HDR)] is selected for [EOTF] in the [Input Setting] menu, images are displayed in HDR (High Dynamic Range). In this manual, this status is described as “HDR display.”

For details on the HDR (High Dynamic Range) display, see page 24.

On Burn-in

Due to the characteristics of the material used in the OLED panel, permanent burn-in or reduction in brightness may occur.

These problems are not a malfunction.

Images that may cause burn-in

- Still images in the HDR display
- Masked images with aspect ratios other than 17:9
- Color bars or images that remain static for a long time

- Character or message displays that indicate settings or the operating state
- On-screen displays such as center markers or area markers
- Images with a frame (including Multi-View displays)

For details on the HDR (High Dynamic Range) display, see page 24.

To reduce the risk of burn-in

- Turn off the character and marker displays
Press the MENU button to turn off the character displays. To turn off the character or marker displays of the connected equipment, operate the connected equipment accordingly. For details, refer to the operation manual of the connected equipment.
- Do not display static images that contain high brightness display, time codes, markers, or logos for extended periods. Consider applying a display method with low level signals of 100% or less.
- Do not display the images with a frame for a long time. Also, consider removing the frame during the Multi-View display, or displaying the signal level of the frame area by about 50% of the display area.
- Reduce the brightness
Reduce the brightness as much as possible or reduce the input signal level when you do not use the display.
- Turn off the power when not in use
Turn off the power if the monitor is not to be used for a prolonged period of time.

Screen saver

This product has a built-in screen saver function to reduce burn-in. When an almost still image is displayed for more than 10 minutes, the screen saver starts automatically and the brightness of the screen decreases.

On a Long Period of Use

Due to an OLED's panel structure and characteristics of materials in its design, displaying static images for extended periods, or using the unit repeatedly in a high temperature/high humidity environments may cause image smearing, burn-in, areas of which brightness is permanently changed, lines, or a decrease in overall brightness.

In particular, continually displaying an image smaller than the monitor screen, such as displaying an image in a different aspect ratio or displaying an image with a frame, may expedite the above issues.

Avoid displaying a still image for an extended period, or using the unit repeatedly in a high temperature/high humidity environment such as an airtight room, or around the outlet of an air conditioner.

To prevent any of the above issues, we recommend reducing brightness slightly, and to turn off the power whenever the unit is not in use.

On the Surface of the Unit

The surface of the unit becomes extremely hot. Do not touch the surface with your hand or body during power distribution. It may cause a burn.

On Long Periods of Continuous Use

Using this unit for extended periods may cause eyestrain or reduction of eyesight.

As soon as you feel physical discomfort or pain, stop using this unit immediately and take a break.

If the physical discomfort or pain remains even after taking a break, consult a physician.

Handling and Maintenance of the Screen

The surface of the screen is specially coated to reduce image reflection. Make sure to observe the following points as improper maintenance procedures may impair the screen's performance. In addition, the screen is vulnerable to damage. Do not scratch or knock against it using a hard object.

- Be sure to disconnect the AC power cord from the AC outlet before performing maintenance.
- The surface of the screen is specially coated. Do not attach adhesive objects, such as stickers, on it.
- The surface of the screen is specially coated. Do not touch the screen directly.
- Wipe the screen surface gently with the supplied cleaning cloth or a soft dry cloth to remove dirt.
- Stubborn stains may be removed with the supplied cleaning cloth, or a soft cloth slightly dampened with a mild detergent solution.
- The screen may become scratched if the cleaning cloth is dusty.
- Never use strong solvents such as alcohol, benzene, thinner, acidic or alkaline detergent, detergent with abrasives, or chemical wipe as these may damage the screen.
- Use a blower to remove dust from the screen surface.

On Dew Condensation

If the unit is suddenly taken from a cold to a warm location, or if ambient temperature suddenly rises, moisture may form on the outer surface of the unit and/or inside of the unit. This is known as condensation. If

condensation occurs, turn off the unit and wait until the condensation clears before operating the unit. Operating the unit while condensation is present may damage the unit.

On Repacking

Do not throw away the carton and packing materials. They make an ideal container which to transport the unit.

Transportation of the Unit

Do not subject the unit to severe vibration or high impact conditions during transportation. Doing so may result in deformation of the internal structure or exterior of the unit, malfunction of the internal parts, or other damage.

Make sure not to expose the unit to strong vibration or high impact when you transport the unit as cargo by truck, ship, or air, or as luggage with a rolling luggage bag.

Disposal of the Unit

- Do not dispose of the unit with general waste. Do not include the monitor with household waste.
- When you dispose of the monitor, you must obey the law in the relative area or country.

On Fan Error

The unit has a built in fan for cooling. When the fan stops and the  (Power) switch indicator blinks in red, turn off the power and contact an authorized Sony dealer.

On the Software Update

This manual contains descriptions on the support of the software version 2.00 (or later).

Therefore, if you use the software version 2.00 (or later) updated from the version 1.00/1.10/1.20, the following functions are different from the descriptions.

- The function on the SDI2 and HDMI cannot be operated.
- The function of the SDI1 corresponds to SDI.

Location and Function of Parts and Controls

Front Panel

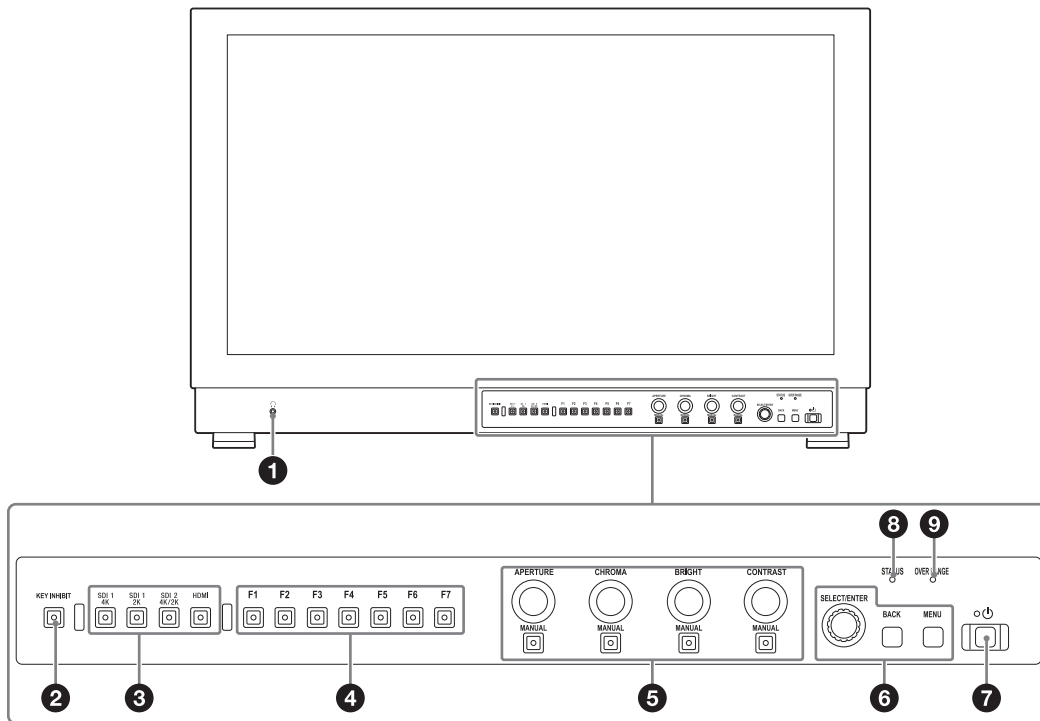

1 (headphones) jack

The audio signal which is selected by the input select button is output in stereo sound.

The output audio can be changed in [Audio Setting] (page 32) of the [User Configuration] menu.

2 KEY INHIBIT button

You can turn the setting value protection on or off. When the setting value is protected with key inhibit, the value cannot be changed. To change the setting value, turn protection off by pressing the button for more than two seconds.

For details, see “Protection of the Setting Values” (page 18).

3 Input select buttons

Press to monitor the signal input to each connector.

SDI1 4K button: To monitor the 4K signal through the SDI 1 IN connector.

SDI1 2K button: To monitor the 2K signal through the SDI 1 IN connector.

SDI2 4K/2K button: To monitor the signal through the SDI 2 IN connector. Select from the menu whether to use as either the SDI2 4K button for monitoring the 4K signal or the SDI2 2K button for monitoring the 2K signal (refer to page 23).

HDMI button: To monitor the signal through the HDMI IN connector.

When you sequentially press the buttons that the signal input has already monitored, you can change to the input setting with [Not Skip] selected.

For details, see [Input Setting Skip] (page 25, 28, 30).

4 Function buttons

You can turn the assigned function on or off.

The factory setting is as follows;

F1 button: [Mono]

F2 button: [Flicker Free]

F3 button: [Blue Only]

F4 button: [Internal Signal]

F5 button: [Internal Signal Pattern]

F6 button: [Marker]

F7 button: [Time Code]

You can assign various functions in [Function Button Setting] (page 30) of the [User Configuration] menu.

The [Function Button Setting] menu can also be

displayed by pressing and holding the function button.

5 Rotary encoder

APERTURE knob: Adjusts the picture sharpness.

Turn the knob to the right to make picture sharper and turn it to the left to make the picture softer. This

adjustment is available while the indicator of the MANUAL button below the knob is lit.

CHROMA knob: Adjusts the color intensity. Turn the knob to the right to increase the intensity and turn to the left to decrease it. This adjustment is available while the adjustment menu is displayed or the indicator of the MANUAL button below the knob is lit.

BRIGHT knob: Adjusts the picture brightness. Turn the knob to the right to increase the brightness and turn to the left to decrease it. This adjustment is available while the adjustment menu is displayed or the indicator of the MANUAL button below the knob is lit.

CONTRAST knob: Adjusts the picture contrast. Turn the knob to the right to increase the contrast and turn to the left to decrease it. This adjustment is available while the adjustment menu is displayed or the indicator of the MANUAL button below the knob is lit.

MANUAL button: Press to perform the adjustment manually with the knob. Each time the button is pressed, the button indicator lights up or goes out. Each adjustment is available with the knobs above each indicator while it is lit.

6 Menu operation buttons

Displays or sets the on-screen menu.

Menu selection control

When the menu is displayed, turn the control to select a menu item or setting value, and then press the control to confirm the setting.

If the menu is not displayed and the menu selection control is pressed, the characters that represent the names of the buttons light up. Also, the names of the functions assigned to the function buttons appear on the screen. Press again to clear it.

Alternatively, if the menu is not displayed and the menu selection control is pressed for more than two seconds, the signal format is displayed on the screen.

BACK button

When the menu is displayed, press the button to reset the value of an item to the previous value (except some items).

MENU button

Press to display the on-screen menu.

Press again to clear the menu.

7 (Power) switch and indicator

When the unit is turned off, press the switch to turn it on. When the unit turns on, the unit starts up with the indicator flashing in green. When the unit is in operation, the indicator lights in green.

Press the switch again to turn off the unit. The indicator goes out.

8 STATUS indicator

Slowly flashes in yellow when the screen saver starts up, and quickly flashes in yellow when a warning during startup occurs.

Lights up in blue during HDR display. Slowly flashes in blue when the screen saver displaying in HDR starts up, and quickly flashes in blue when a warning during startup occurs.

For details on the HDR (High Dynamic Range) display, see page 8, 24.

9 OVER RANGE indicator

Lights in amber when ABL (Automatic Brightness Limiter) starts.

About error/warning signals of the indicator

While the unit is in use, the (Power) switch indicator or OVER RANGE indicator of the front panel may show error or warning signals.

If an error display appears, refer to Sony qualified service personnel.

Error display

OVER RANGE indicator	Power indicator	Symptom
–	Flashes in red (every second)	Power abnormality, circuit board abnormality, sensor abnormality
–	Flashes in red (every two seconds)	Fan abnormality

Warning display

OVER RANGE indicator	Power indicator	Symptom
Flashes in amber (every second) ¹⁾ (every 2 seconds) ²⁾	–	Decreases the brightness to protect the panel from overheating
Lights in amber	–	ABL starts

- 1) When using in the HDR display, regardless of the input signal, the screen brightness may decrease when the protective function for the OLED panel activates. To avoid the brightness decrease due to the protection function, it is recommended to keep the temperature of the peripheral environment of the unit around 25 °C.
- 2) When using in the HDR display, if a high level signal is continuously displayed on the same part, the brightness of the high signal level part may decrease to lower the temperature of the OLED panel. To avoid decreasing brightness from this protection function, do not allow a bright signal to be displayed continuously on the same area.

For details on the HDR (High Dynamic Range) display, see page 24.

About operations using the Sony monitor control unit (the controller)

When the optional BKM-16R or BKM-17R is connected, the following operations are available with the buttons of the controller.

For details on each function, see “Adjustment Using the Menus” (page 19).

Menu operation buttons

Button	Operations
MENU button	When the on-screen menu is not displayed, press the button to display the menu. Press again to clear the menu. When the menu is displayed, press the button to reset the value of an item to the previous value.
ENTER button	When the menu is displayed, press the button to confirm a menu item or setting value. However, displaying the signal format by pressing and holding the button is not available.
UP button DOWN button	When the menu is displayed, press the button to select a menu item or setting value.

Power button

Button	Operations
MONITOR / ⏻ switch	Switches the operating mode of the monitor. Press the button for the sleep mode when the monitor is in the operating mode. The power indicator on the front panel lights in red. Press the button for the operating mode when the monitor is in the sleep mode.

Rotary encoder/MANUAL buttons

Knob	Operations
CONTRAST knob	Adjusts the picture contrast.
BRIGHT knob	Adjusts the picture brightness.
CHROMA knob	Adjusts the color intensity.
PHASE knob	Available only in the color temperature adjusting menu. No other operations are available.

Button	Operations
CONTRAST MANUAL button	Press the button to adjust contrast manually.
BRIGHT MANUAL button	Press the button to adjust brightness manually.
CHROMA MANUAL button	Press the button to adjust color intensity manually.

Button	Operations
PHASE MANUAL button	Available only in the color temperature adjusting menu. No other operations are available.

Numeric buttons

Button	Operations
1 to 9 button	Turns on or off functions assigned to the numeric buttons from 1 to 9 on the controller. The factory default settings are following: 1 button: [SDI1 4K] 2 button: [SDI1 2K] 3 button: [SDI2 4K] 4 button: [SDI2 2K] 5 button: [HDMI] 6 button: [Native Scan] 7 button: [Internal Signal] 8 button: [Internal Signal Pattern] 9 button: [Marker] Each function can be assigned at [Function/Numeric Button Setting] (page 36) of the [Serial Remote] menu.
Ent button	Operates similar to the ENTER button on the controller.

Function buttons

Button	Operations
F1 to F16 button	Turns on or off functions assigned to the function buttons on the controller. The following functions are available. [Mono], [Blue Only], [R Off], [G Off], [B Off], [Character Off], [Native Scan], [Interlace], [Aperture] (selecting the manually adjusted setting in [Aperture]), [Marker], [Aspect Marker], [Area Marker1], [Area Marker2], [Center Marker], [Aspect Marker-Line], [Aspect Blanking-Black], [Aspect Blanking-Half], [Flicker Free] ¹⁾ 1) For BKM-17R only.

Note

Up to a total of three BKM-16R or BKM-17R units can be simultaneously connected to a BVM-X300 unit.

Input Signals and Adjustable/Setting Items

Item	Input signal							
	SDI 1/2 4K			SDI 1/2 2K			HDMI	
	YCbCr	RGB	XYZ	YCbCr	RGB	XYZ	YCbCr	RGB
APERTURE	○	○	×	○	○	×	○	○
CHROMA ¹⁾	○	○	×	○	○	×	○	○
BRIGHT	○	○	○	○	○	○	○	○
CONTRAST ²⁾	○	○	○	○	○	○	○	○
User Preset	○	○	○	○	○	○	○	○
Color Temp.	○	○	○	○	○	○	○	○
Manual Adjustment (Color Temp.)	○	○	○	○	○	○	○	○
Flicker Free ³⁾	○	○	○	○	○	○	○	○
Screen Saver ³⁾	○	○	○	○	○	○	○	○
RGB Range	×	○	×	×	○	×	×	○
YCC Range	○	×	×	○	×	×	○	×
Color Space	○	○	×	○	○	×	○	○
EOTF	○	○	×	○	○	×	○	○
Transfer Matrix	○	×	×	○	×	×	○	×
Internal Signal	○	○	×	○	○	×	○	○
Internal Signal Pattern	○	○	×	○	○	×	○	○
Mono ⁴⁾	○	○	○	○	○	○	○	○
Blue Only	○	○	○	○	○	○	○	○
R Off	○	○	○	○	○	○	○	○
G Off	○	○	○	○	○	○	○	○
B Off	○	○	○	○	○	○	○	○
Character Off	○	○	○	○	○	○	○	○
Interlace ⁵⁾	×	×	×	○	○	○	○	○
Native Scan	○	○	○	○	○	○	○	○
1080I/PsF ⁶⁾	×	×	×	○	○	○	×	×
Area and Aspect Marker	○	○	○	○	○	○	○	○
Gamut Marker ⁷⁾	○	○	×	○	○	×	○	○
Input Setting	○	○	○	○	○	○	○	○
Time Code	○	○	○	○	○	○	×	×
Volume	○	○	○	○	○	○	○	○
Audio Muting	○	○	○	○	○	○	○	○
Relative Contrast 1/2, Relative Contrast 1/3, Relative Contrast 1/4 ⁸⁾	○	○	○	○	○	○	○	○

○ : Adjustable/can be set
 × : Not adjustable/cannot be set

- 1) When the EOTF is set to [S-Log3(HDR)], [S-Log2(HDR)], [SMPTE ST 2084(HDR)], [RGB(SG1.2)], [ITU-R BT.2100(HLG)], or [S-Log3(Live HDR)], this does not function.
- 2) The available maximum brightness is reduced by half when the interlace display is selected.
- 3) Available only during SDR (Standard Dynamic Range) display.
- 4) When the RGB signal is input, the brightness signal based on the transfer matrix selected in [Transfer Matrix] is displayed.

- 5) The setting is available when 50I, 59.94I, 60I, 25PsF, 29.97PsF, or 30PsF signals are input in the SDI 2K input and the interlace process is selected in the [1080I/PsF] setting.
- 6) The setting is available when 50I, 59.94I, 60I, 25PsF, 29.97PsF, or 30PsF signals are input in the SDI 2K input.
- 7) The setting is available while [ITU-R BT.2020] is selected for [Color Space].
- 8) This setting is available only when the EOTF is set to [2.4(HDR)], [S-Log3(HDR)], [S-Log2(HDR)], [SMPTE ST 2084(HDR)], [RGB(SG1.2)], [ITU-R BT.2100(HLG)], or [S-Log3(Live HDR)].

Rear Panel

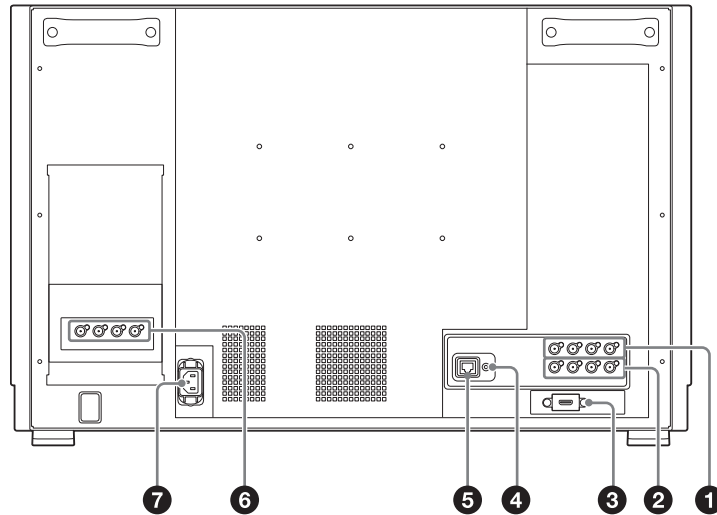

1 SDI 1 IN (SDI 1 input) connectors (BNC)

Input connectors for serial digital signals.

For details, see “Connecting the SDI Signals” (page 37).

2 MONITOR OUT (SDI output) connectors (BNC)

Output connectors for serial digital signals.

Outputs the signal that is input to the SDI 1 IN connector when the SDI 1 IN connector signal is displayed.

The 1 to 4 connectors output the signal that is input to the corresponding SDI 1 IN connector.

Outputs the signal that is input to the SDI 2 IN connector when the SDI 2 IN connector signal is displayed.

The 1 to 4 connectors output the signal that is input to the corresponding SDI 2 IN connector.

Outputs the signal that is input to the SDI 1/2 IN connector when the signal that is input to the HDMI IN connector is displayed.

Note

SDI output is only activated when the power is on.

3 HDMI IN (HDMI input) connector

Input connector for HDMI ¹⁾ signals.

HDMI (High-Definition Multimedia Interface) is an interface that supports both video and audio on a single digital connection, allowing you to enjoy high quality digital picture and sound. The HDMI specification supports HDCP (High-bandwidth Digital Content Protection), a copy protection technology that incorporates coding technology for digital video signals.

1) The terms HDMI and HDMI High-Definition Multimedia Interface, and the HDMI Logo are trademarks or registered trademarks of HDMI Licensing Administrator, Inc. in the United States and other countries.

Note

To input the HDMI signal equivalent to 4K, use an HDMI cable bearing the Premium High Speed logo within a length of 3 meters (Sony product recommended).

To input other signals, we recommend using a Premium High Speed HDMI cable within a length of 3 meters.

4 AUDIO output connector (stereo mini jack)

The audio signal of the input signal which is selected by the input select button on the front panel is output.

The output audio signal can be changed in [Audio Setting] (page 32) of the [User Configuration] menu.

5 LAN (10/100) connector

Connect to the Sony Monitor Control Unit BKM-16R or BKM-17R by using a 10BASE-T/100BASE-TX LAN cable (shielded type, optional).

CAUTION

- For safety, do not connect the connector for peripheral device wiring that might have excessive voltage to this port. Follow the instructions for this port.
- When you connect the LAN cable of the unit to peripheral device, use a shielded-type cable to prevent malfunction due to radiation noise.
- The connection speed may be affected by the network system. This unit does not guarantee the communication speed or quality of 10BASE-T/100BASE-TX.

ATTENTION

Par mesure de sécurité, ne raccordez pas le connecteur pour le câblage de périphériques pouvant avoir une tension excessive à ce port. Suivez les instructions pour ce port.

VORSICHT

Aus Sicherheitsgründen nicht mit einem Peripheriegerät-Anschluss verbinden, der zu starke Spannung für diese Buchse haben könnte. Folgen Sie den Anweisungen für diese Buchse.

⑥ SDI 2 IN (SDI 2 input) connectors (BNC)

Input connectors for serial digital signals.

For details, see “Connecting the SDI Signals” (page 37).

⑦ AC IN socket

Connect the supplied AC power cord.

Connecting the AC Power Cord

- 1 Plug the AC power cord into the AC IN socket on the rear panel. Then, attach the AC plug holder (supplied) to the AC power cord.

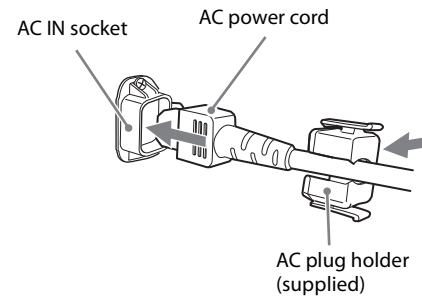

- 2 Slide the AC plug holder over the cord until it locks.

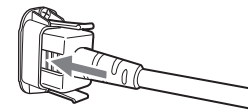

To remove the AC power cord

Pull out the AC plug holder while pressing the lock levers.

Connecting the HDMI cable

- 1 Remove the two screws on the both sides of the HDMI IN connector.

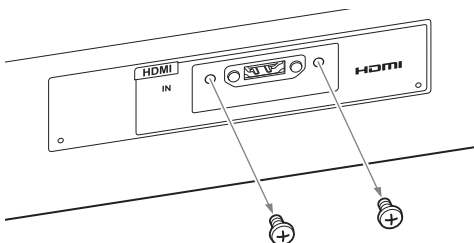

- 2 Attach the HDMI cable holder (supplied) with the removed screws.

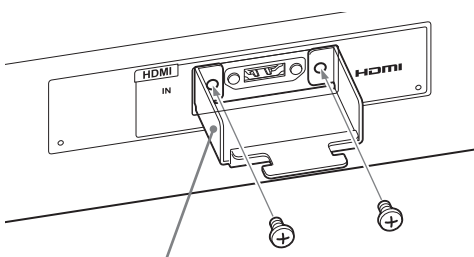

HDMI cable holder (supplied)

- 3 Insert the HDMI cable and fix with a commercially-available cable fixer (1 piece).

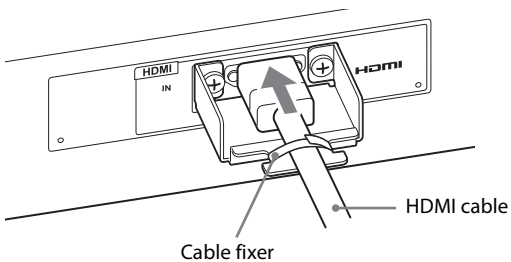

Cable fixer

HDMI cable

Using the Menu

The unit is equipped with an on-screen menu for making various adjustments and settings such as picture control, input setting, set setting change, etc.

The current settings are displayed in place of the ■■■■ marks on the illustrations of the menu screen.

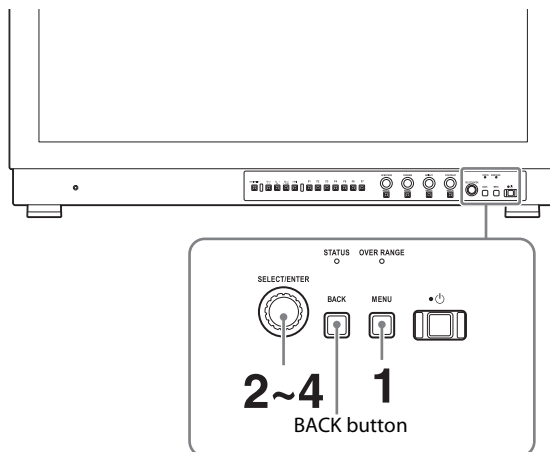

- 1 Press the MENU button.

The menu appears.
The menu presently selected is shown in yellow.

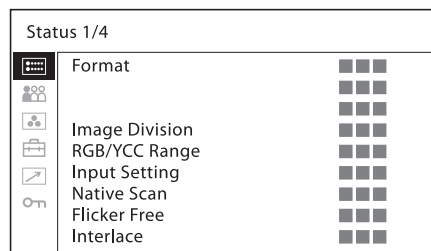

- 2 Turn the menu selection control to select a menu, then press the menu selection control.

The menu icon presently selected is shown in yellow and setting items are displayed.

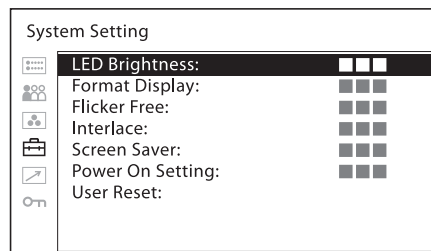

- 3 Select an item.

Turn the menu selection control to select the item, then press the menu selection control. The item to be changed is displayed in yellow. If the menu consists of multiple pages, turn the menu selection control to go to the desired menu page.

4 Make the setting or adjustment on an item.

When changing the adjustment level:

To increase the number, turn the menu selection control right.

To decrease the number, turn the menu selection control left.

Press the menu selection control to confirm the number, then restore the original screen.

When changing the setting:

Turn the menu selection control to change the setting, then press the menu selection control to confirm the setting.

When returning the adjustment or setting to the previous value:

Press the BACK button before pressing the menu selection control.

Notes

- An item displayed in black cannot be accessed. You can access the item if it is displayed in white.
- If the [Password Lock] has been turned [On], the setting values of the color temperature for [User1] and the User Preset for [User Preset1] cannot be changed. To change the values, enter the password.

For details on the password lock function, see "[Security] menu" (page 36).

To return the display to the previous screen

Press the BACK button.

To clear the menu

Press the MENU button.

The menu disappears automatically if a button is not pressed for one minute.

About the memory of the settings

The settings are automatically stored in the monitor memory.

Protection of the Setting Values

Protecting the setting values using the KEY INHIBIT button

You can protect the setting values using the KEY INHIBIT button.

When the values are protected by the key inhibit function, you cannot change the values.

To change the values, press and hold the KEY INHIBIT button for more than two seconds to set the protection of the setting value to off.

Protecting the setting values using [Password Lock]

You can protect the setting values of the color temperature for [User1] and the User Preset for [User Preset1] using [Password Lock].

When the values are protected with a password, you need to enter the password during the following operations.

- When you change the color temperature values for [User1] using [Adjust Gain/Bias] or [Copy From].
- When you change the User Preset values for [User Preset1].

For details, see [Password Lock] (page 36).

Adjustment Using the Menus

Items

The screen menu of this monitor consists of the following items.

[Status] (the items indicate the current settings.)

Displays the unit setting status, etc.

For details on the displayed items, see “[Status] menu” (page 19).

[User Preset Setting]

- [User Preset]
 - [Color Temp.]
 - [Contrast]
 - [Brightness]
 - [Chroma]
 - [Aperture]
 - [Volume]
 - [Marker Preset]
- [Copy From]

[Color Temp.]

- [Color Temp.]
 - [R/G/B Gain]
 - [R/G/B Bias]
- [Manual Adjustment]
 - [Adjust Gain/Bias]
 - [Signal]
- [Copy From]

[User Configuration]

- [System Setting]
 - [LED Brightness]
 - [Format Display]
 - [Flicker Free]
 - [Interlace]
 - [Screen Saver]
 - [Power On Setting]
 - [User Reset]
- [Input Setting]
 - [SDI1 4K/UHD Input Setting]
 - [SDI1 2K/HD Input Setting]
 - [Input Select]
 - [SDI2 4K/UHD Input Setting]
 - [SDI2 2K/HD Input Setting]
 - [HDMI Input Setting]

- [Function Button Setting]
- [Audio Setting]
 - [SDI Audio Setting]
- [Internal Signal Setting]
 - [Internal Signal]
 - [Pattern]
- [Gamut Marker Setting]
 - [Gamut Marker]
 - [Target]
 - [Type]
- [Area and Aspect Marker Setting]
 - [Marker Preset]
- [Time Code Setting]
 - [Time Code]
 - [Format]
 - [Position]
 - [Transparency]

[Serial Remote]

- [Monitor]
 - [Network Setting]
 - [Connection]
- [Controller]
 - [Network Setting]
 - [Function/Numeric Button Setting]

[Security]

- [Password Lock]
 - [Color Temp./User Pre.]
 - [Change Password]

Adjusting and Changing the Settings

[Status] menu

The status menu displays the current status of the unit. The following items are displayed:

Page 1

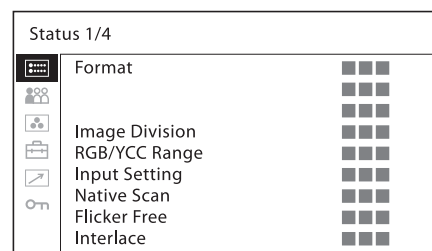

- [Format]
- [Image Division]
- [RGB/YCC Range]
- [Input Setting]
- [Native Scan]
- [Flicker Free]

- [Interlace]

Page 2

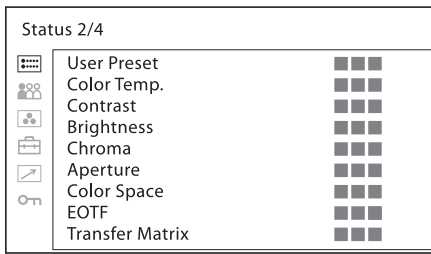

- [User Preset]
- [Color Temp.]
- [Contrast]
- [Brightness]
- [Chroma]
- [Aperture]
- [Color Space]
- [EOTF]
- [Transfer Matrix]

Page 3 (for the SDI signal input)

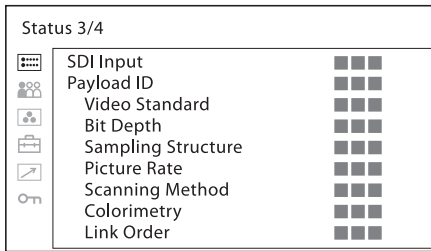

- [SDI Input]
- [Payload ID]
- [Video Standard]
- [Bit Depth]
- [Sampling Structure]
- [Picture Rate]
- [Scanning Method]
- [Colorimetry]
- [Link Order]

Page 3 (for the HDMI signal input)

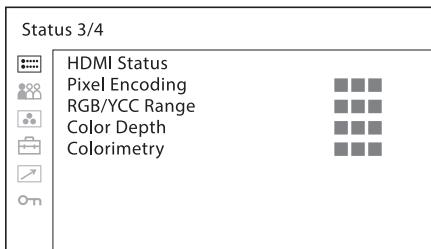

- [HDMI Status]
- [Pixel Encoding]
- [RGB/YCC Range]
- [Color Depth]
- [Colorimetry]

Page 4

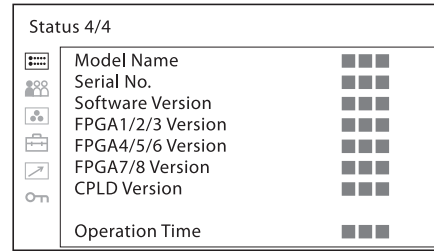

- [Model Name]
- [Serial No.]
- [Software Version]
- [FPGA1/2/3 Version]
- [FPGA4/5/6 Version]
- [FPGA7/8 Version]
- [CPLD Version]
- [Operation Time]

👤 [User Preset Setting] menu

You can set and adjust various items in the User Preset. The preset values can be copied from other preset data. To apply the User Preset settings and adjustments in this menu, select [User Preset] in the [Input Setting] menu (page 25, 28, 30).

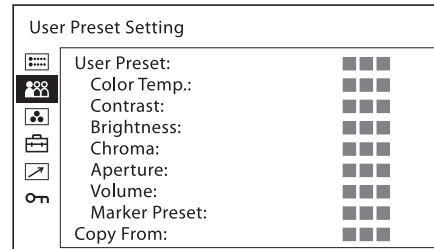

Submenu	Setting
[User Preset]	Select the User Preset data to be set. <ul style="list-style-type: none"> • [User Preset1] • [User Preset2] • [User Preset3] • [User Preset4] • [User Preset5] • [User Preset XYZ]

Note

When the XYZ format signal is input, set to [User Preset XYZ].

Submenu	Setting
[Color Temp.]	Select the color temperature to be used in the selected User Preset. <ul style="list-style-type: none"> • [D65] • [D93] • [D61] • [D55] • [DCI] • [User1] • [User2] • [User3] • [User4] • [User5] • [DCI XYZ]

Notes

- If you measure the color temperatures of different display types, such as CRT, LCD, or OLED, by using a common (or general) color analyzer that is based on CIE 1931, and adjust the xy chromaticity to the same value, the appearance may be different because of optical spectrum differences. To compensate for this difference, the [D65], [D93], [D61], and [D55] settings of the monitor are adjusted by an offset ¹⁾.
- When the XYZ format signal is input, set to [DCI XYZ].

[Contrast]	Set the contrast of the selected User Preset. ²⁾
[Brightness]	Set the brightness of the selected User Preset. ²⁾
[Chroma]	Set the chroma level of the selected User Preset. ²⁾

Note

When [S-Log3(HDR)], [S-Log2(HDR)], [SMPTE ST 2084(HDR)], [RGB(SG1.2)], [ITU-R BT.2100(HLG)], or [S-Log3(Live HDR)] is selected for [EOTF] in the [Input Setting] menu, this does not function. For details on the EOTF setting, see page 24.

[Aperture]	Set the aperture of the selected User Preset.
[Volume]	Adjusts the volume of the selected User Preset.
[Marker Preset]	Select the marker preset to be used in the selected User Preset. <ul style="list-style-type: none"> • [Marker Preset1] • [Marker Preset2] • [Marker Preset3] • [Marker Preset4] • [Marker Preset5]

Submenu	Setting
[Copy From]	Copies the other User Preset data to the selected User Preset. The appropriate settings are saved in [Default(D65)] for D65, [Default(D93)] for D93, and [Default(XYZ)] for XYZ format signal. <ul style="list-style-type: none"> • [User Preset1] • [User Preset2] • [User Preset3] • [User Preset4] • [User Preset5] • [Default(D65)] • [Default(D93)] • [User Preset XYZ] • [Default(XYZ)]

- 1) The offset value applied ($x-0.006$, $y-0.011$) is based on the Judd's function to the CIE 1931 (x , y) value.
- 2) If you select each setting item while the MANUAL button is turned on, the MANUAL button is turned off and the manually set value is copied.

☰ [Color Temp.] menu

You can select and adjust the color temperature. You need to use the measurement instrument to adjust the white balance.

Recommended: Konica Minolta Color Analyzer CA-210/310

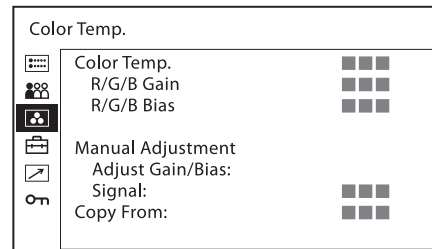

Submenu	Setting
[Manual Adjustment]	If you set the [Color Temp.] to the [User1] to [User5] setting, you can adjust the color temperature. The set values are memorized. <ul style="list-style-type: none"> • [Adjust Gain/Bias]: <ul style="list-style-type: none"> • [R/G/B Gain]: Adjusts the color balance (gain) of R (red)/G (green)/B (blue). • [R/G/B Bias]: Adjusts the color balance (bias) of R (red)/G (green)/B (blue). • [Signal]: <ul style="list-style-type: none"> • [Internal]: Select to adjust the white balance by using the internal signal. When the XYZ format signal is input, the internal signal is displayed as D65 48cd/m². • [External]: Select to adjust the white balance by using the signals input from an external device.

Submenu	Setting
[Copy From]	Select from the following items to copy the white balance data of the selected color temperature. <ul style="list-style-type: none"> • [D65] • [D93] • [D61] • [D55] • [DCI] • [User1] • [User2] • [User3] • [User4] • [User5] • [DCI XYZ]

Notes

- If [Password Lock] has been turned [On], the [User1] value is protected by a password. To change the values, enter the password.
- The color temperature data is used commonly regardless of the signal format or the EOTF setting. When the color temperature is adjusted under certain conditions, the adjusted result is reflected in all displays on which the same color temperature data is set.

[User Configuration] menu

Executes [System Setting], [Input Setting], [Function Button Setting], [Audio Setting], [Internal Signal Setting], [Gamut Marker Setting], [Area and Aspect Marker Setting], and [Time Code Setting].

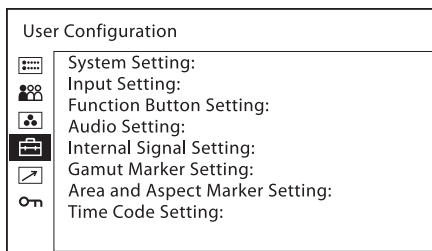

[System Setting]

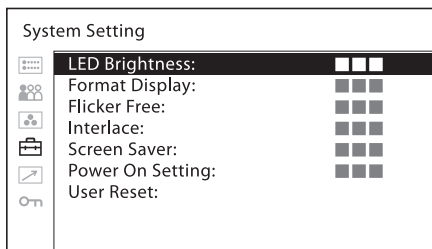

Submenu	Setting
[LED Brightness]	Selects the brightness of the indicator's LED of the buttons, power switch, etc. <ul style="list-style-type: none"> • [High]: The level of the LED brightness becomes high. • [Middle]: The level of the LED brightness becomes medium. • [Low]: The level of the LED brightness becomes low.

Note

The level of the character's brightness which shows the button name is [High] or [Low]. When [Middle] is selected, the brightness is set to the same as [Low].

[Format Display]	Selects the display mode of the signal format. <ul style="list-style-type: none"> • [Auto]: The format is displayed for about five seconds when the input of the signal starts. • [Off]: The display is hidden.
------------------	---

[Flicker Free]	Set this to [On] to enable view images without flicker. An OLED panel can provide superior video responsiveness and scan driving, reproducing images with little contour or afterimage. However, scan driving can cause flicker when input signals have a low vertical frequency (24P/PsF, 50i, etc.). Set [Flicker Free] to [On] to greatly reduce this phenomenon. With this mode set to on, quick-moving images may exhibit contours or an afterimage.
----------------	--

Note

In the HDR display, [Flicker Free] cannot be selected. [On] is always set for signals of vertical frequency 24 Hz, 25 Hz, 48 Hz, and 50Hz. [Off] is always set for signals of 30 Hz and 60 Hz.

For details on the HDR (High Dynamic Range) display, see page 24.

[Interlace]	The interlace signal is displayed as the interlace picture by inserting the black line without I/P conversion processing. A picture faithful to the original signal with the same feel as a CRT is gained. <ul style="list-style-type: none"> • [On]: Interlaced video is displayed. • [Off]: The progressive signals by I/P conversion processing are displayed.
-------------	---

Note

The brightness of HDR display is reduced by half when the interlace display is selected. Except for HDR display, the normal brightness is set by increasing the value of gain. However, the maximum brightness is reduced by half.

Submenu	Setting
[Screen Saver]	<p>Sets the screen saver function [On] or [Off].</p> <ul style="list-style-type: none"> • [On]: If a still image is displayed for more than 10 minutes, the brightness of the screen is automatically decreased to reduce burn-in. The screen returns to normal brightness when you input a video signal to the unit or operate the buttons on the front panel of the unit. While the screen saver is active, the STATUS indicator flashes every two seconds. Before the screen saver starts up, the STATUS indicator flashes every second to notify users that the screen saver will start up. • [Off]: The screen saver function is deactivated.
<p>Note</p> <p>In the HDR display, this setting is forcibly set to [On].</p> <p><i>For details on the HDR (High Dynamic Range) display, see page 24.</i></p>	
[Power On Setting]	<p>Sets this unit's setting status after the unit is turned on. Select from [Last Memory], [Input Setting1], [Input Setting2], [Input Setting3], [Input Setting4], [Input Setting5], [Input Setting6], [Input Setting7], or [Input Setting8].</p>
[User Reset]	<p>Returns to the factory default setting except for the following:</p> <ul style="list-style-type: none"> • Color temperature for [User1] • Color temperature for [User2] • Color temperature for [User3] • Color temperature for [User4] • Color temperature for [User5] • User Preset for [User Preset1] • Network setting of the monitor • Password setting <ul style="list-style-type: none"> • [Cancel]: Cancels reset. • [Confirm]: Resets the unit.

[Input Setting]

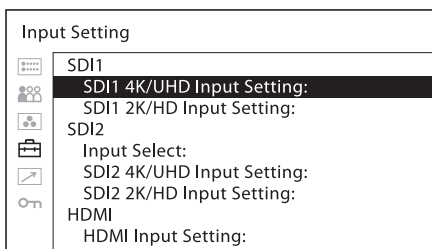

[Input Select]

Sets the operation of the SDI2 4K/2K button.

- **[4K]:** Operates as the SDI2 4K button.

- **[2K]:** Operates as the SDI2 2K button.

[SDI1 4K/UHD Input Setting] / [SDI2 4K/UHD Input Setting]

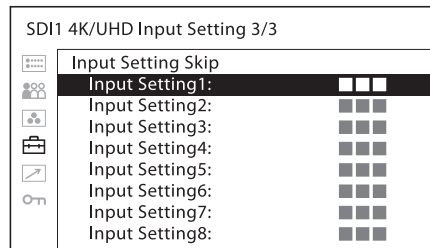
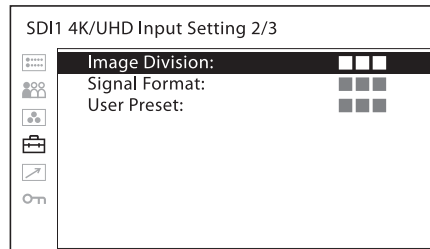
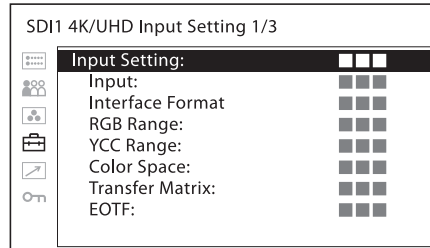

Submenu	Setting
[Input Setting]	<p>Sets the input setting of the SDI 4K signal.</p> <ul style="list-style-type: none"> • [Input Setting1] • [Input Setting2] • [Input Setting3] • [Input Setting4] • [Input Setting5] • [Input Setting6] • [Input Setting7] • [Input Setting8]
[Input]	<p>Set the input connector of the SDI 4K signal.</p> <ul style="list-style-type: none"> • [Input1,2,3&4]: Select to use SDI IN [1], SDI IN [2], SDI IN [3], and SDI IN [4] with Quad Link. • [Input1&2]: Select to use SDI IN [1] and SDI IN [2] with Dual Link. • [Input3&4]: Select to use SDI IN [3] and SDI IN [4] with Dual Link.
[Interface Format]	<p>Displays the interface format of the SDI 4K signal.</p> <ul style="list-style-type: none"> • [Quad-Link 3G/HD-SDI] • [Dual-Link 3G-SDI]

Submenu	Setting
[RGB Range]	<p>Select from the following when [Signal Format] is set to RGB.</p> <ul style="list-style-type: none"> • [Full]: 0 to 1023 (10bit) / 0 to 4095 (12bit) • [Limited]: 64 to 940 (10bit) / 256 to 3760 (12bit) • [SDI Full Range] ¹⁾: 4 to 1019 (10bit) / 16 to 4076 (12bit) <p>1) This manual regards the Full Range signals that are scaled to the quantized value except the inhibit code on the SDI standard as the SDI Full Range.</p>
[YCC Range]	<p>Select from the following when [Signal Format] is set to YCbCr.</p> <ul style="list-style-type: none"> • [Full]: 0 to 1023 (10bit) / 0 to 4095 (12bit) • [Limited]: 64 to 940 (Y), 64 to 960 (Cb/Cr) (10bit) / 256 to 3760 (Y), 256 to 3840 (Cb/Cr) (12bit) (Default value) • [SDI Full Range] ¹⁾: 4 to 1019 (Y/Cb/Cr) (10bit) / 16 to 4076 (Y/Cb/Cr) (12bit) <p>1) This manual regards the Full Range signals that are scaled to the quantized value except the inhibit code on the SDI standard as the SDI Full Range.</p>
[Color Space]	<p>Select the color space from the following:</p> <ul style="list-style-type: none"> • [ITU-R BT.709] • [EBU] • [SMPTE-C] • [Native] ¹⁾ • [S-Gamut/S-Gamut3] • [S-Gamut3.Cine] • [DCI-P3] • [ITU-R BT.2020] <p>1) Displays with the unit's color space of the three primary color chromaticity points. This is the widest color space setting which the unit can reproduce.</p>

Note

When [Signal Format] is set to [Auto] or [444 XYZ 12bit] and the XYZ signal is input, the optimum setting for the XYZ signal is fixed.

Submenu	Setting
[Transfer Matrix]	<p>Select the transfer matrix from the following:</p> <ul style="list-style-type: none"> • [ITU-R BT.709] • [ITU-R BT.2020] <p>Set the following depending on the [Color Space] setting.</p> <p>When [ITU-R BT.2020] is selected: Select [ITU-R BT.2020].</p> <p>When [ITU-R BT.709] is selected: Select [ITU-R BT.709].</p> <p>When another item is selected: Select the transfer matrix setting of the device which outputs the signal.</p>
[EOTF]	<p>Select the gamma from the following:</p> <ul style="list-style-type: none"> • [2.2] • [2.4] • [2.6] • [CRT] • [2.4(HDR)] • [S-Log3(HDR)] • [S-Log2(HDR)] • [SMPTE ST 2084(HDR)] • [RGB(SG1.2)] ¹⁾ • [ITU-R BT.2100(HLG)] • [S-Log3(Live HDR)] <p>1) For the specifications of [RGB(SG1.2)], see "About [RGB(SG1.2)]" (page 26).</p>

Note

When [Signal Format] is set to [Auto] or [444 XYZ 12bit] and the XYZ signal is input, the optimum setting for the XYZ signal is fixed.

When [ITU-R BT.2100(HLG)] is selected

- **[HLG System Gamma]:** Sets the system gamma of the HLG. Set from 1.000 to 1.500.

Note

The HDR display is a method to faithfully display the brightness of signals defined of 100% or more level without compressing the brightness parts.

- You can check the bright portions exceeding the displayable brightness of the unit by decreasing the contrast.
- In the HDR display, the cooling fan is forcibly rotated regardless of outside temperature.
- In the HDR display, the screen saver is forcibly set. [Off] cannot be selected.
- In the HDR display, [Flicker Free] cannot be selected. [On] is always set for signals of vertical frequency 24 Hz, 25 Hz, 48 Hz, and 50 Hz. [Off] is always set for signals of 30 Hz and 60 Hz.

Submenu	Setting
	<ul style="list-style-type: none"> The protective function for the OLED panel activates and inserts the black level in one field according to the input signal. When the signal to display high brightness images on the larger part of the screen is input, blinking may occur due to the protection function. This is not a malfunction. There is no effect on the throughout. Using the unit with the high brightness display for extended periods may cause eyestrain or reduction of eyesight. Be sure to take an occasional break when using. Follow RECOMMENDATION ITU-R BT.1702 "Guidance for the reduction of photosensitive epileptic seizures caused by television" or other guidelines to use. In the HDR display, the display surface may emit heat when high brightness images are output. Do not touch the surface. Do not display static images that contains high brightness display, time codes, markers, or logos for extended periods to reduce the risk of burn-in. Consider to apply a displaying method with a low level signals of 100% or less. If a high level signal is continuously displayed on the same area in the HDR display, the protection function activates wherein the brightness of the bright part in the display decreases to control the rise of the surface temperature of the OLED panel. When the level of the bright part decreases or the change of its position continues, the protection function is deactivated. However, it may take a while to deactivate. In that case, operating the buttons on the front panel deactivates the protection function immediately. When [Signal Format] is set to [Auto] or [444 XYZ 12bit] and the XYZ signal is input, the optimum setting for the XYZ signal is fixed. The brightness adjustment of [ITU-R BT.2100(HLG)] supports the ITU-R BT.2100-2 standard. The brightness adjustment of [SMPTE ST 2084(HDR)] supports the ITU-R BT.814-4 standard.

Submenu	Setting
	<ul style="list-style-type: none"> The brightness-adjustment specifications of [S-Log3(HDR)], [S-Log2(HDR)], and [S-Log3(Live HDR)] are the same as the specification of [SMPTE ST 2084(HDR)].
[Image Division]	Set the image division of the SDI 4K signal. <ul style="list-style-type: none"> [Auto]: Select for the Auto setting. [2SI]: Select to receive images of the 2 sample Interleave system. [Square]: Select to receive images of the Square system.
[Signal Format]	Select from the following when [Interface Format] is [Quad-Link 3G/HD-SDI]. <ul style="list-style-type: none"> [Auto] [422 YCbCr 10bit] [444 RGB 10bit] [444 YCbCr 10bit] [444 RGB 12bit] [444 YCbCr 12bit] [444 XYZ 12bit] [422 YCbCr 10bit] is set when [Interface Format] is [Dual-Link 3G-SDI].
[User Preset]	Select the User Preset data to be applied. <ul style="list-style-type: none"> [User Preset1] [User Preset2] [User Preset3] [User Preset4] [User Preset5] [User Preset XYZ]
Note	
	When the XYZ format signal is input, set to [User Preset XYZ].
[Input Setting Skip]	Sets the skip setting when changing the input setting with Input select buttons (refer to page 11), BKM-16R or BKM-17R. When [Not Skip] is selected, the input setting changes in sequential order every time Input select buttons are pressed. Select [Skip]/[Not Skip] for each input setting of [Input Setting1] to [Input Setting8]. <ul style="list-style-type: none"> [Skip]: Skips. [Not Skip]: Does not skip.

About [S-Log3(Live HDR)]

[S-Log3(Live HDR)] is the setting for which this unit is used as the reference monitor in the S-Log3 Live HDR workflow¹⁾ which Sony advocates. Displays the S-Log3 input signal adding the system gamma. This system gamma is set so that the compatibility with the monitoring of the conventional (SDR) environment is valued and you can perform suitable picture expression without discomfort when adjusting the picture of the HDR camera.

1) Refer to the explanation of the Live HDR workflow on the “What’s HDR” page.

About [RGB(SG1.2)]

EOTF is specified in the following specifications.

$$\text{EOTF of [RGB(SG1.2)]} = [\text{OETF}]^{-1} \otimes \text{OOTF}$$

OETF: provided by ARIB STD-B67

OOTF: System gamma = 1.2 (System gamma is applied for RGB.)

[SDI1 2K/HD Input Setting] / [SDI2 2K/HD Input Setting]

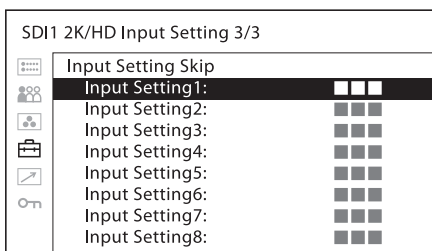
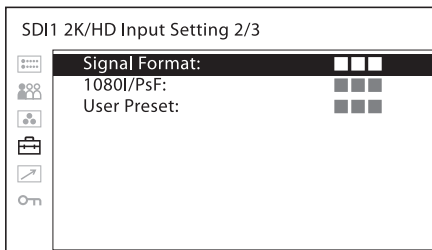
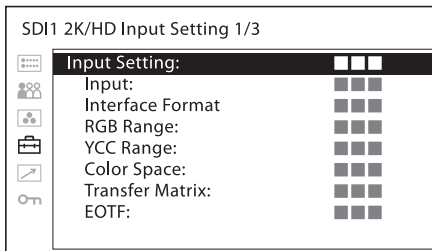

Submenu	Setting
[Input Setting]	Sets the input setting of the SDI 2K signal. <ul style="list-style-type: none"> • [Input Setting1] • [Input Setting2] • [Input Setting3] • [Input Setting4] • [Input Setting5] • [Input Setting6] • [Input Setting7] • [Input Setting8]

Submenu	Setting
[Input]	Set the input connector of the SDI 2K signal. <ul style="list-style-type: none"> • [Input1]: Select to use SDI IN [1] with Single Link. • [Input2]: Select to use SDI IN [2] with Single Link. • [Input3]: Select to use SDI IN [3] with Single Link. • [Input4]: Select to use SDI IN [4] with Single Link. • [Input1&2]: Select to use SDI IN [1] and SDI IN [2] with Dual Link. • [Input3&4]: Select to use SDI IN [3] and SDI IN [4] with Dual Link.
[Interface Format]	Displays the interface format of the SDI 2K signal. <ul style="list-style-type: none"> • [Single-Link 3G/HD-SDI]: For Single Link. • [Dual-Link 3G/HD-SDI]: For Dual Link of 3G/HD-SDI.
[RGB Range]	Select from the following when [Signal Format] is set to RGB. <ul style="list-style-type: none"> • [Full]: 0 to 1023 (10bit) / 0 to 4095 (12bit) • [Limited]: 64 to 940 (10bit) / 256 to 3760 (12bit) • [SDI Full Range]¹⁾: 4 to 1019 (10bit) / 16 to 4076 (12bit) <p>1) This manual regards the Full Range signals that are scaled to the quantized value except the inhibit code on the SDI standard as the SDI Full Range.</p>
[YCC Range]	Select from the following when [Signal Format] is set to YCbCr. <ul style="list-style-type: none"> • [Full]: 0 to 1023 (10bit) / 0 to 4095 (12bit) • [Limited]: 64 to 940 (Y), 64 to 960 (Cb/Cr) (10bit) / 256 to 3760 (Y), 256 to 3840 (Cb/Cr) (12bit) (Default value) • [SDI Full Range]¹⁾: 4 to 1019 (Y/Cb/Cr) (10bit) / 16 to 4076 (Y/Cb/Cr) (12bit) <p>1) This manual regards the Full Range signals that are scaled to the quantized value except the inhibit code on the SDI standard as the SDI Full Range.</p>

Submenu	Setting
[Color Space]	<p>Select the color space from the following:</p> <ul style="list-style-type: none"> • [ITU-R BT.709] • [EBU] • [SMPTE-C] • [Native] ¹⁾ • [S-Gamut/S-Gamut3] • [S-Gamut3.Cine] • [DCI-P3] • [ITU-R BT.2020] <p>1) Displays with the unit's color space of the three primary color chromaticity points. This is the widest color space setting which the unit can reproduce.</p> <p>Note</p> <p>When [Signal Format] is set to [Auto] or [444 XYZ 12bit] and the XYZ signal is input, the optimum setting for the XYZ signal is fixed.</p>
[Transfer Matrix]	<p>Select the transfer matrix from the following:</p> <ul style="list-style-type: none"> • [ITU-R BT.709] • [ITU-R BT.2020] <p>Set the following depending on the [Color Space] setting.</p> <p>When [ITU-R BT.2020] is selected: Select [ITU-R BT.2020].</p> <p>When [ITU-R BT.709] is selected: Select [ITU-R BT.709].</p> <p>When another item is selected: Select the transfer matrix setting of the device which outputs the signal.</p> <p>Note</p> <p>When [Signal Format] is set to [Auto] or [444 XYZ 12bit] and the XYZ signal is input, the optimum setting for the XYZ signal is fixed.</p>
[EOTF]	<p>Select the gamma from the following:</p> <ul style="list-style-type: none"> • [2.2] • [2.4] • [2.6] • [CRT] • [2.4(HDR)] • [S-Log3(HDR)] • [S-Log2(HDR)] • [SMPTE ST 2084(HDR)] • [RGB(SG1.2)] ¹⁾ • [ITU-R BT.2100(HLG)] • [S-Log3(Live HDR)] <p>1) For the specifications of [RGB(SG1.2)], see "About [RGB(SG1.2)]" (page 26).</p> <p>When [ITU-R BT.2100(HLG)] is selected</p> <ul style="list-style-type: none"> • [HLG System Gamma]: Sets the system gamma of the HLG. Set from 1.000 to 1.500.

Submenu	Setting
	<p>Note</p> <p>The HDR display is a method to faithfully display the brightness of signals defined of 100% or more level without compressing the brightness parts.</p> <ul style="list-style-type: none"> • You can check the bright portions exceeding the displayable brightness of the unit by decreasing the contrast. • In the HDR display, the cooling fan is forcibly rotated regardless of outside temperature. • In the HDR display, the screen saver is forcibly set. [Off] cannot be selected. • In the HDR display, [Flicker Free] cannot be selected. [On] is always set for signals of vertical frequency 24 Hz, 25 Hz, 48 Hz, and 50 Hz. [Off] is always set for signals of 30 Hz and 60 Hz. • The protective function for the OLED panel activates and inserts the black level in one field according to the input signal. When the signal to display high brightness images on the larger part of the screen is input, blinking may occur due to the protection function. This is not a malfunction. There is no effect on the throughout. • Using the unit with the high brightness display for extended periods may cause eyestrain or reduction of eyesight. Be sure to take an occasional break when using. • Follow RECOMMENDATION ITU-R BT.1702 "Guidance for the reduction of photosensitive epileptic seizures caused by television" or other guidelines to use. • In the HDR display, the display surface may emit heat when high brightness images are output. Do not touch the surface. • Do not display static images that contains high brightness display, time codes, markers, or logos for extended periods to reduce the risk of burn-in. Consider to apply a displaying method with a low level signals of 100% or less.

Submenu	Setting
	<ul style="list-style-type: none"> If a high level signal is continuously displayed on the same area in the HDR display, the protection function activates wherein the brightness of the bright part in the display decreases to control the rise of the surface temperature of the OLED panel. When the level of the bright part decreases or the change of its position continues, the protection function is deactivated. However, it may take a while to deactivate. In that case, operating the buttons on the front panel deactivates the protection function immediately. When [Signal Format] is set to [Auto] or [444 XYZ 12bit] and the XYZ signal is input, the optimum setting for the XYZ signal is fixed. The brightness adjustment of [ITU-R BT.2100(HLG)] supports the ITU-R BT.2100-2 standard. The brightness adjustment of [SMPTE ST 2084(HDR)] supports the ITU-R BT.814-4 standard. The brightness-adjustment specifications of [S-Log3(HDR)], [S-Log2(HDR)], and [S-Log3(Live HDR)] are the same as the specification of [SMPTE ST 2084(HDR)].
[Signal Format]	<p>Sets the signal format of the SDI 2K signal.</p> <ul style="list-style-type: none"> [Auto] [422 YCbCr 10bit] [444 RGB 10bit] [444 YCbCr 10bit] [444 RGB 12bit] [444 YCbCr 12bit] [444 XYZ 12bit]
[1080I/PsF]	<p>Set how to display when 50I, 59.94I, 60I, 25PsF, 29.97PsF, or 30PsF SDI 2K signals are input. 23.98 Hz and 24 Hz signals are processed as the PsF signal.</p> <ul style="list-style-type: none"> [Auto]: When Payload ID is added to SDI signals, they are processed based on the ID data. They are processed as the interlace signals without the Payload ID. [PsF]: Processes as the PsF signal. [Interlace]: Processes as the interlace signal.

Submenu	Setting
[User Preset]	<p>Select the User Preset data to be applied.</p> <ul style="list-style-type: none"> [User Preset1] [User Preset2] [User Preset3] [User Preset4] [User Preset5] [User Preset XYZ]
Note	
	<p>When the XYZ format signal is input, set to [User Preset XYZ].</p>

[Input Setting Skip]	<p>Sets the skip setting when changing the input setting with Input select buttons (refer to page 11), BKM-16R or BKM-17R.</p> <p>When [Not Skip] is selected, the input setting changes in sequential order every time Input select buttons are pressed. Select [Skip]/[Not Skip] for each input setting of [Input Setting1] to [Input Setting8].</p> <ul style="list-style-type: none"> [Skip]: Skips. [Not Skip]: Does not skip.
----------------------	---

[HDMI Input Setting] (HDMI input only)

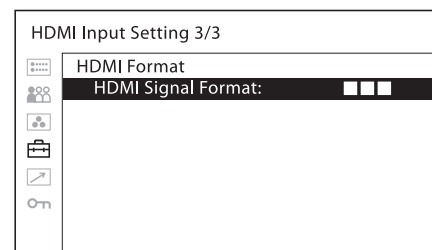
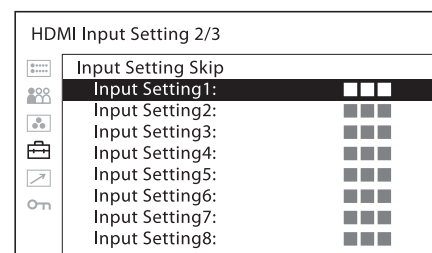
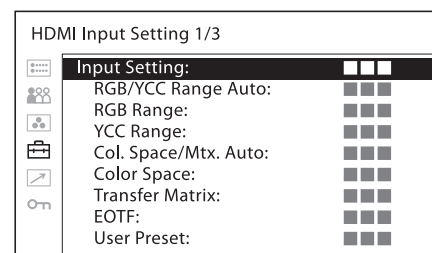

Submenu	Setting
[Input Setting]	<p>Sets the input setting of the HDMI signal.</p> <ul style="list-style-type: none"> • [Input Setting1] • [Input Setting2] • [Input Setting3] • [Input Setting4] • [Input Setting5] • [Input Setting6] • [Input Setting7] • [Input Setting8]
[RGB/YCC Range Auto]	<p>Select how to set the RGB/YCC Range.</p> <ul style="list-style-type: none"> • [On]: Use RGB/YCC Range according to the input signal information. • [Off]: Use RGB/YCC Range that was set in the menu.
[RGB Range]	<p>When [RGB/YCC Range Auto] is set to [Off] and the signal is RGB, select from the following:</p> <ul style="list-style-type: none"> • [Full]: 0 to 1023 (10bit) / 0 to 4095 (12bit) • [Limited]: 64 to 940 (10bit) / 256 to 3760 (12bit)
[YCC Range]	<p>When [RGB/YCC Range Auto] is set to [Off] and the signal is YCbCr, select from the following:</p> <ul style="list-style-type: none"> • [Full]: 0 to 1023 (10bit) / 0 to 4095 (12bit) • [Limited]: 64 to 940 (10bit) / 256 to 3760 (12bit)
[Col. Space/Mtx. Auto]	<p>Select how to set the color space and transfer matrix.</p> <ul style="list-style-type: none"> • [On]: Use the color space and transfer matrix according to the input signal information. • [Off]: Use the color space and transfer matrix that was set in the menu.
[Color Space]	<p>Select the color space from the following:</p> <ul style="list-style-type: none"> • [ITU-R BT.709] • [EBU] • [SMPTE-C] • [Native] ¹⁾ • [S-Gamut/S-Gamut3] • [S-Gamut3.Cine] • [DCI-P3] • [ITU-R BT.2020] <p>1) Displays with the unit's color space of the three primary color chromaticity points. This is the widest color space setting which the unit can reproduce.</p>

Note

This setting can be set only when [Col. Space/Mtx. Auto] is set to [Off].

Submenu	Setting
[Transfer Matrix]	<p>Select the transfer matrix from the following:</p> <ul style="list-style-type: none"> • [ITU-R BT.709] • [ITU-R BT.2020] <p>Set the following depending on the [Color Space] setting.</p> <p>When [ITU-R BT.2020] is selected: Select [ITU-R BT.2020].</p> <p>When [ITU-R BT.709] is selected: Select [ITU-R BT.709].</p> <p>When another item is selected: Select the transfer matrix setting of the device which outputs the signal.</p>
[EOTF]	<p>Select the gamma from the following:</p> <ul style="list-style-type: none"> • [2.2] • [2.4] • [2.6] • [CRT] • [2.4(HDR)] • [S-Log3(HDR)] • [S-Log2(HDR)] • [SMPTE ST 2084(HDR)] • [RGB(SG1.2)] ¹⁾ • [ITU-R BT.2100(HLG)] • [S-Log3(Live HDR)] <p>1) For the specifications of [RGB(SG1.2)], see "About [RGB(SG1.2)]" (page 26).</p> <p>When [ITU-R BT.2100(HLG)] is selected</p> <ul style="list-style-type: none"> • [HLG System Gamma]: Sets the system gamma of the HLG. Set from 1.000 to 1.500.

Note

This setting can be set only when [Col. Space/Mtx. Auto] is set to [Off].

Note

The HDR display is a method to faithfully display the brightness of signals defined of 100% or more level without compressing the brightness parts.

- You can check the bright portions exceeding the displayable brightness of the unit by decreasing the contrast.
- In the HDR display, the cooling fan is forcibly rotated regardless of outside temperature.
- In the HDR display, the screen saver is forcibly set. [Off] cannot be selected.
- In the HDR display, [Flicker Free] cannot be selected. [On] is always set for signals of vertical frequency 24 Hz, 25 Hz, 48 Hz, and 50 Hz. [Off] is always set for signals of 30 Hz and 60 Hz.

Submenu	Setting
	<ul style="list-style-type: none"> The protective function for the OLED panel activates and inserts the black level in one field according to the input signal. When the signal to display high brightness images on the larger part of the screen is input, blinking may occur due to the protection function. This is not a malfunction. There is no effect on the throughout. Using the unit with the high brightness display for extended periods may cause eyestrain or reduction of eyesight. Be sure to take an occasional break when using. Follow RECOMMENDATION ITU-R BT.1702 "Guidance for the reduction of photosensitive epileptic seizures caused by television" or other guidelines to use. In the HDR display, the display surface may emit heat when high brightness images are output. Do not touch the surface. Do not display static images that contains high brightness display, time codes, markers, or logos for extended periods to reduce the risk of burn-in. Consider to apply a displaying method with a low level signals of 100% or less. If a high level signal is continuously displayed on the same area in the HDR display, the protection function activates wherein the brightness of the bright part in the display decreases to control the rise of the surface temperature of the OLED panel. When the level of the bright part decreases or the change of its position continues, the protection function is deactivated. However, it may take a while to deactivate. In that case, operating the buttons on the front panel deactivates the protection function immediately.
[User Preset]	Select the User Preset data to be applied. <ul style="list-style-type: none"> [User Preset1] [User Preset2] [User Preset3] [User Preset4] [User Preset5] [User Preset XYZ]
Note	
When the XYZ format signal is input, set to [User Preset XYZ].	

Submenu	Setting
[Input Setting Skip]	Sets the skip setting when changing the input setting with Input select buttons (refer to page 11), BKM-16R or BKM-17R. When [Not Skip] is selected, the input setting changes in sequential order every time Input select buttons are pressed. Select [Skip]/[Not Skip] for each input setting of [Input Setting1] to [Input Setting8]. <ul style="list-style-type: none"> [Skip]: Skips. [Not Skip]: Does not skip.
[HDMI Format]	Change the setting to receive images in a high-resolution HDMI signal ¹⁾ or a HDR-compatible HDMI signal. <p>1) Signals in resolutions of 3840 × 2160 or 4096 × 2160 are listed below:</p> <ul style="list-style-type: none"> 4:4:4 RGB/YCbCr-50P/60P-8bit signals 4:2:2 YCbCr-50P/60P-12bit signals 4:4:4 RGB/YCbCr-24P/25P/30P-10/12bit signals <ul style="list-style-type: none"> [Standard Format]: Select to use for a standard HDMI format signal. [Enhanced Format]: Select to use for a high-resolution HDMI format signal or HDR-compatible HDMI format signal.
Notes	
<ul style="list-style-type: none"> Images and sounds may not be output correctly with [Enhanced Format]. In that case, select [Standard Format]. To display the corresponding signal with [Enhanced Format], use a Premium High-Speed HDMI cable within a length of 3 meters (Sony product recommended). 	

[Function Button Setting]

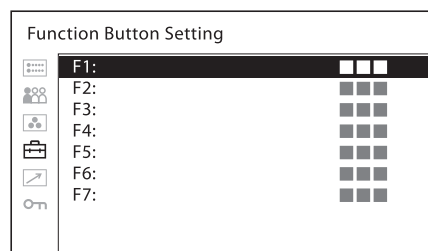

Submenu	Setting
[F1] to [F7]	Assigns functions to the function buttons of the front panel and turns the function on or off. The [Function Button Setting] menu can also be displayed by pressing and holding the function button, and the setting can be changed. Note that you cannot move to the other menu.

About functions that can be assigned to the function buttons on the unit and the buttons 1 to 9 on the Sony monitor control unit (the controller)

[Mono]

Press the button to display a monochrome picture. When the button is pressed again, the monitor switches automatically to color mode.

[Blue Only]

Press the button to eliminate the red and green signals. Only the blue signal is displayed as an apparent monochrome picture on the screen. This facilitates observation of signal noise.

[Native Scan]

Press the button to switch between the image with the scaling display ([Off]) and the image displayed directly from pixels ([On]).

Notes

- When Native Scan (On) is selected, 2K resolution signals are displayed while enlarged horizontally and vertically with the following proportion (repeating pixel values).
 - 1280 × 720 signal: × 3
 - Others: × 2
- 640 × 480/60P, 720 × 480/60P, and 720 × 576/50P signals for HDMI are not enlarged up to the end of the display.

[Audio Muting]

Press to turn off the sound from the headphone output. To turn on the sound, press this once again or turn the volume up adjusting [Volume] of the [User Preset Setting] menu (page 20).

[Flicker Free] ¹⁾

Press the button to change the flicker free setting.

[R Off]

Press the button to turn off the R (red) signal.

[G Off]

Press the button to turn off the G (green) signal.

[B Off]

Press the button to turn off the B (blue) signal.

[Character Off]

Press the button to hide the menu while adjusting the picture. When the button is pressed again, the monitor switches to the previous display.

[Internal Signal]

Press the button to display the internal signal.

[Internal Signal Pattern]

Press the button to change the pattern of the internal signal when the internal signal is displayed. With every press of the button, the picture switches to [PLUGE], [Gray], [White], [5 Step], [Ramp], and [Color Bars], in this order.

[Interlace]

Press the button to display with the interlace.

[Gamut Marker]

Press the button to display the gamut marker.

[Input Setting1]

[Input Setting2]

[Input Setting3]

[Input Setting4]

[Input Setting5]

[Input Setting6]

[Input Setting7]

[Input Setting8]

Press the button so that the setting switches to the assigned input setting.

[Marker]

Press the button to display the aspect marker, area marker 1, area marker 2 or center marker with the selected marker preset setting.

[Aspect Marker]

Press the button to display the aspect marker.

[Area Marker1]

Press the button to display area marker 1.

[Area Marker2]

Press the button to display area marker 2.

[Center Marker]

Press the button to display the center marker.

[Aspect Marker-Line]

Press the button to display the line of the aspect marker.

[Aspect Blanking-Half]

Press the button to set the aspect blanking to half.

[Aspect Blanking-Black]

Press the button to set the aspect blanking to black.

Note

The [Marker] to [Aspect Blanking-Black] settings are not available in the following cases:

- When the input signal is no sync signal
- When the internal signal is displayed
- When the screen saver is activated

[Time Code]

Press the button to display the Time Code. Adjust the settings for the Time Code in [Time Code Setting] (page 35).

[Relative Contrast 1/2]

Press the button to reduce the contrast of the screen to 1/2 during the HDR display.

[Relative Contrast 1/3]

Press the button to reduce the contrast of the screen to 1/3 during the HDR display.

[Relative Contrast 1/4]

Press the button to reduce the contrast of the screen to 1/4 during the HDR display.

Note

When [Relative Contrast 1/2], [Relative Contrast 1/3], or [Relative Contrast 1/4] is set to on, the screen that has the contrast value that multiplies the displaying contrast setting value (including the manual setting) by 1/2, 1/3, or 1/4 is displayed.

[SDI1 4K] ²⁾

Press the button to monitor the 4K signal through the SDI 1 IN connector (operates in the same way as the SDI1 4K button on the front panel).

[SDI1 2K] ²⁾

Press the button to monitor the 2K signal through the SDI 1 IN connector (operates in the same way as the SDI1 2K button on the front panel).

[SDI2 4K] ²⁾

Press the button to monitor the 4K signal through the SDI 2 IN connector (operates in the same way as the SDI2 4K/2K button on the front panel while [Input Select] of SDI2 is set to [4K]).

[SDI2 2K] ²⁾

Press the button to monitor the 2K signal through the SDI 2 IN connector (operates in the same way as the SDI2 4K/2K button on the front panel while [Input Select] of SDI2 is set to [2K]).

[HDMI] ²⁾

Press the button to monitor the signal through the HDMI connector.

- 1) You can assign this function to the buttons 1 to 9 on the controller only when using BKM-17R.
- 2) You cannot assign this function to the function buttons on the unit. It can only be assigned to the buttons 1 to 9 on the controller.

[Audio Setting]

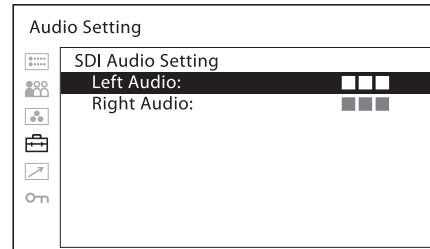

Submenu	Setting
[SDI Audio Setting]	Sets the audio channel when SDI signal is input. <ul style="list-style-type: none"> • [Left Audio]: Select from channels [CH1] to [CH16]. • [Right Audio]: Select from channels [CH1] to [CH16]. When a channel from [CH1] to [CH8] is selected in [Left Audio], you can select a channel from [CH1] to [CH8] in [Right Audio]. When a channel from [CH9] to [CH16] is selected in [Left Audio], you can select a channel from [CH9] to [CH16] in [Right Audio].

[Internal Signal Setting]

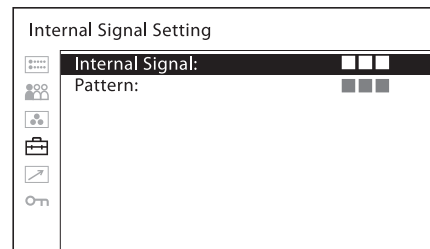

Submenu	Setting
[Internal Signal]	Select the internal signal display. <ul style="list-style-type: none"> • [On] • [Off]
[Pattern]	Select the pattern of the internal signal. <ul style="list-style-type: none"> • [PLUGE] • [Gray] • [White] • [5 Step] • [Ramp] • [Color Bars]

[Gamut Marker Setting]

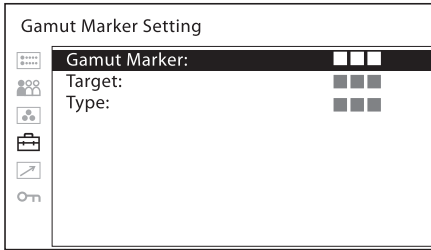

Submenu	Setting
[Gamut Marker]	<p>Turns the gamut marker [On]/[Off]. The zebra pattern can be displayed for the signal outside of the targeted color space while [ITU-R BT.2020] is selected for [Color Space].</p> <ul style="list-style-type: none"> • [On]: Displays the gamut marker. • [Off]: Disables the gamut marker function.
[Target]	<p>Sets the targeted color space. The zebra pattern can be displayed for the signal outside of the selected color space.¹⁾</p> <ul style="list-style-type: none"> • [ITU-R BT.709] • [DCI-P3]
Notes	
	<ul style="list-style-type: none"> • The setting is available while [ITU-R BT.2020] is selected for [Color Space]. • The setting does not depend on the status of picture control functions such as contrast, chroma or white balance. • When the input signal which is included the noise composition is over the targeted color space, the zebra pattern display may emphasize the noise.
[Type]	<ul style="list-style-type: none"> • [Type1]: Displays the black zebra pattern. • [Type2]: Displays the black & white zebra pattern.

1) For detecting the color space, use the following definitions of the transmission gamma based on the selected [EOTF].

The EOTF's selection on the unit	The definitions used while detecting the color space
[2.2], [2.4], [2.6], [CRT], [2.4(HDR)]	ITU-R BT.2020
[S-Log3(HDR)], [S-Log3(Live HDR)]	sLog3
[S-Log2(HDR)]	sLog2
[SMPTE ST 2084(HDR)]	SMPTE ST 2084
[RGB(SG1.2)]	ARIB STD-B67
[ITU-R BT.2100(HLG)]	ITU-R BT.2100

[Area and Aspect Marker Setting]

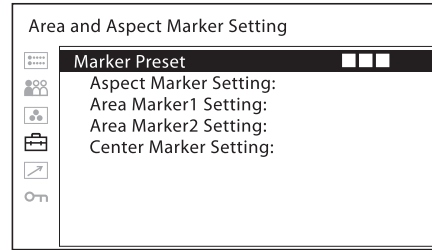

[Marker Preset]

Displays the selected marker preset data.

[Aspect Marker Setting]

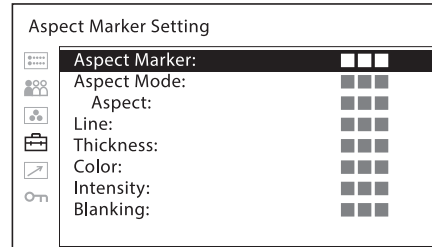

Submenu	Setting
[Aspect Marker]	Sets whether or not to display the aspect marker ([Off] or [On]).
[Aspect Mode]	<p>Sets the aspect ratio of the aspect marker.</p> <p>You can select from [16:9], [15:9], [14:9], [13:9], [4:3], [2.39:1], [2.35:1], [1.85:1], [1.66:1], [1.896:1] or [Variable].</p>
[Aspect]	<p>Sets the aspect ratio of the aspect marker when [Variable] is selected in [Aspect Mode].</p> <p>Set to 1.00:1 to 3.00:1. (Default value: [1.78]:1)</p>
[Line]	Sets whether or not to display the line of the aspect marker ([Off] or [On]).
[Thickness]	Sets the thickness of the aspect marker. Set to 1 to 5 (dots). (Default value: [2])
[Color]	<p>Sets the color of the aspect marker.</p> <p>You can select from [White] (white), [Red] (red), [Green] (green), [Blue] (blue), [Yellow] (yellow), [Cyan] (cyan) or [Magenta] (magenta).</p>
[Intensity]	<p>Sets the luminance of the aspect marker.</p> <p>You can select from [High] (bright) or [Low] (dark).</p>
[Blanking]	<p>Sets the blanking outside the area of the aspect marker.</p> <ul style="list-style-type: none"> • [Off]: Blanking is released. • [Black]: Sets blanking. • [Half]: Sets half blanking.

[Area Marker1 Setting]

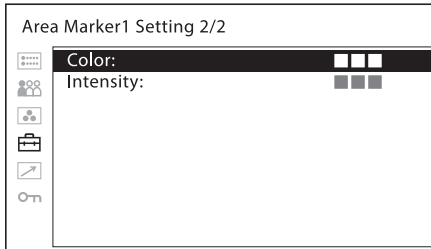
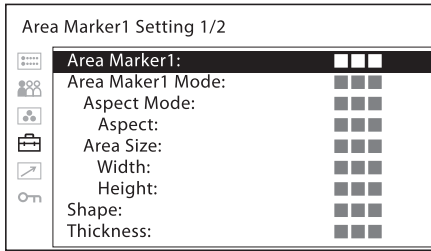

Submenu	Setting
[Area Marker1]	Sets whether or not to display area marker 1 ([Off] or [On]).
[Area Marker1 Mode]	Sets the display mode of the area marker. You can select [Safe Area Marker] or [Flexible Area Marker].
[Aspect Mode]	Sets the aspect ratio of area marker 1 when [Safe Area Marker] is selected in [Area Marker1 Mode]. You can select from [16:9], [15:9], [14:9], [13:9], [4:3], [2.39:1], [2.35:1], [1.85:1], [1.66:1], [1.896:1] or [Variable].







Note

When [Variable(dots)] is selected in [Area Size], the size of area marker 1 is set in the pixels of the input signal and the [Aspect Mode] setting becomes invalid.

When [Variable] is selected in [Aspect Mode]

- **[Aspect]:** Sets the aspect ratio of area marker 1. Set to 1.00:1 to 3.00:1. (Default value: [1.78]:1)

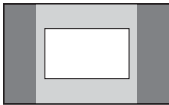
Submenu	Setting
[Area Size]	<p>Sets the size of area marker 1 when [Safe Area Marker] is selected in [Area Marker1 Mode]. You can select from [80%], [88%], [90%], [93%], [Variable(%)] or [Variable(dots)].</p> <p>When [Area Size] is set to [Variable(%)] or [Variable(dots)]</p> <ul style="list-style-type: none"> • [Width]: Sets the width of area marker 1. Set to 050 to 100 (%) when [Variable(%)] is selected. (Default value: [080]) Set to 640 to 4096 (dots) when [Variable(dots)] is selected. Set one digit each. (Default value: [1024]) • [Height]: Sets the height of area marker 1. Set to 050 to 100 (%) when [Variable(%)] is selected. (Default value: [080]) Set to 360 to 2160 (dots) when [Variable(dots)] is selected. Set one digit each. (Default value: [576])
[H Position]	Sets the horizontal position of the marker at the top left corner of the image display area as the starting point when [Flexible Area Marker] is selected in [Area Marker1 Mode]. You can select a position from between [0] to [4095].
[V Position]	Sets the vertical position of the marker at the top left corner of the image display area as the starting point when [Flexible Area Marker] is selected in [Area Marker1 Mode]. You can select a position from between [0] to [2159].
[Width]	Sets the width of the marker when [Flexible Area Marker] is selected in [Area Marker1 Mode]. You can select a width from between [1] to [4096].
[Height]	Sets the height of the marker when [Flexible Area Marker] is selected in [Area Marker1 Mode]. You can select a height from between [1] to [2160].



Submenu	Setting
[Shape]	<p>Sets the shape of area marker 1. You can select from [Shape A], [Shape B] or [Shape C].</p> <ul style="list-style-type: none"> [Shape A]  [Shape B]  [Shape C] 
<p>Note</p> <p>When [Safe Area Marker] is selected in [Area Marker1 Mode], the size of the area differs depending on the [Aspect Mode] setting.</p> <p>With 1.896:1</p> <div style="display: flex; justify-content: space-around;"> <div style="text-align: center;">  <p>80% [Aspect Mode] is set to [1.896:1]</p> </div> <div style="text-align: center;">  <p>80% [Aspect Mode] is set to [4:3]</p> </div> </div> <p>With 4:3</p> <div style="display: flex; justify-content: space-around;"> <div style="text-align: center;">  <p>80% [Aspect Mode] is set to [1.896:1]</p> </div> <div style="text-align: center;">  <p>80% [Aspect Mode] is set to [4:3]</p> </div> </div>	
[Thickness]	Sets the thickness of area marker 1. Set to 1 to 5 (dots). (Default value: [2])
[Color]	Sets the color of area marker 1. You can select from [White] (white), [Red] (red), [Green] (green), [Blue] (blue), [Yellow] (yellow), [Cyan] (cyan) or [Magenta] (magenta).
[Intensity]	Sets the luminance of area marker 1. You can select from [High] (bright) or [Low] (dark).

[Area Marker2 Setting]

Sets area marker 2. The set items are the same as for [Area Marker1 Setting].

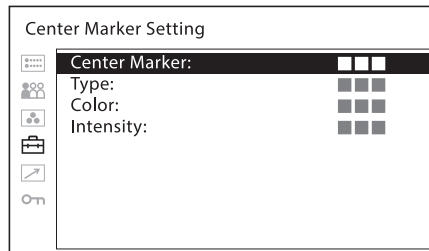
[Center Marker Setting]

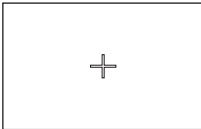

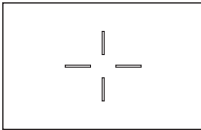
Submenu	Setting
[Center Marker]	Sets whether or not to display the center marker ([Off] or [On]).
[Type]	<p>Sets the display mode of the center marker. You can select from [Type1], [Type2], or [Type3].</p> <ul style="list-style-type: none"> [Type1]  [Type2]  [Type3] 
[Color]	Sets the color of the center marker. You can select from [White] (white), [Red] (red), [Green] (green), [Blue] (blue), [Yellow] (yellow), [Cyan] (cyan) or [Magenta] (magenta).
[Intensity]	Sets the luminance of the center marker. You can select from [High] (bright) or [Low] (dark).

[Time Code Setting]

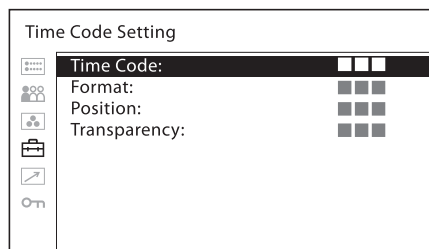

Submenu	Setting
[Time Code]	Selects [On] to display the time code and [Off] not to display.
[Format]	Sets the time code format. <ul style="list-style-type: none"> • [VITC]: To display the time code in VITC format. • [LTC]: To display the time code in LTC format.
[Position]	Sets the position of the time code display. You can select between [Top] and [Bottom].
[Transparency]	Sets the background transparency of the time code display. <ul style="list-style-type: none"> • [Black]: The background becomes black. • [Half]: The background becomes translucent.

[Serial Remote] menu

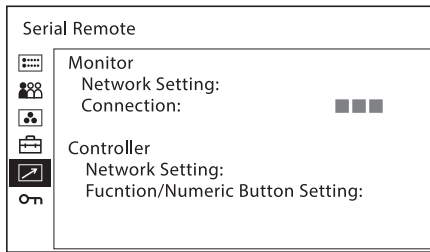

Submenu	Setting
[Monitor]	Sets the monitor setting. <ul style="list-style-type: none"> • [Monitor ID]: Sets the ID of the monitor. • [Group ID]: Sets the group ID of the monitor. • [IP Address]: Sets the IP address. • [Subnet Mask]: Sets the subnet mask. ([255.255.255.000]) • [Default Gateway]: Sets the default gateway [On] or [Off]. • [Address]: Sets the default gateway. • [Cancel]: Selects to cancel the setting. • [Confirm]: Selects to save the setting.
[Connection]	Sets the connection of the monitor and the controller. <ul style="list-style-type: none"> • [Peer to Peer]: for one to one connection • [LAN]: for connection via a network
[Controller]	Sets the controller setting. <ul style="list-style-type: none"> • [IP Address]: Sets the IP address. • [Subnet Mask]: Sets the subnet mask. ([255.255.255.000]) • [Default Gateway]: Sets the default gateway [On] or [Off]. • [Address]: Sets the default gateway. • [Cancel]: Selects to cancel the setting. • [Confirm]: Selects to save the setting.

Submenu	Setting
[Function/ Numeric Button Setting]	Set functions to be assigned to the F1 to F16 buttons and 1 to 9 buttons on the controller. <i>For available functions with BVM-X300, see page 13.</i> <i>For the functions which are assigned to the 1 to 9 buttons, see "About functions that can be assigned to the function buttons on the unit and the buttons 1 to 9 on the Sony monitor control unit (the controller)" (page 31).</i>

Note

The [Controller] menu is available when the menu is displayed via BKM-16R or BKM-17R. (Only when BKM-16R or BKM-17R is connected with the Peer to Peer connection or Single connection.)

[Security] menu

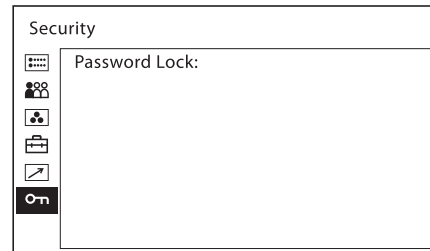

Submenu	Setting
[Password Lock]	You can protect the setting with a password so that the settings saved in the color temperature for [User1] and the User Preset for [User Preset1] cannot be changed. When you protect the values with a password, set a four-digit number. The initial password is "0000". When you use [Password Lock], change the initial password first. <ul style="list-style-type: none"> • [Color Temp./User Pre.]: Select [On] to protect the setting values saved in the color temperature for [User1] and the User Preset for [User Preset1]. Select [Off] to not protect with the password. • [Change Password]: Changes the password.

Note

If you forget the password, refer to Sony qualified service personnel.

Connecting the SDI Signals

Single Link 3G/HD-SDI, Dual Link 3G/HD-SDI, and Quad Link 3G/HD-SDI signals can be input to the SDI 1 IN and SDI 2 IN connectors of this unit.

Signals up to 4-channel Single Link 3G/HD-SDI signals, signals up to 2-channel Dual Link 3G/HD-SDI signals, or 1-channel Quad Link 3G/HD-SDI signals can be input to the SDI 1 IN connector and the SDI 2 IN connector respectively. Use the appropriate input connectors depending on the input signal, referring to the tables below.

Connecting the Dual Link 3G/HD-SDI signal

Connector	Input signal
SDI IN 1	3G/HD-SDI Link 1
SDI IN 2	3G/HD-SDI Link 2

or

Connector	Input signal
SDI IN 3	3G/HD-SDI Link 1
SDI IN 4	3G/HD-SDI Link 2

When only 1-channel Dual Link 3G/HD-SDI signal is input, the Single Link 3G/HD-SDI signals of up to 2 channels can be input via the SDI IN connectors that are not used for the Dual Link 3G/HD-SDI signal.

Connecting the Quad Link 3G/HD-SDI signal

To input 2-sample interleave division signals

Connector	Input signal
SDI IN 1	3G-SDI Link 1
SDI IN 2	3G-SDI Link 2
SDI IN 3	3G-SDI Link 3
SDI IN 4	3G-SDI Link 4

To input Square division signals

Connector	Input signal
SDI IN 1	Mapping signal of Sub image 1 (upper-left screen)
SDI IN 2	Mapping signal of Sub image 2 (upper-right screen)
SDI IN 3	Mapping signal of Sub image 3 (lower-left screen)

Connector	Input signal
SDI IN 4	Mapping signal of Sub image 4 (lower-right screen)

Troubleshooting

This section may help you isolate the cause of a problem and as a result, eliminate the need to contact technical support.

- **The unit cannot be operated** → The key protection function is on. Press and hold the KEY INHIBIT button for more than two seconds to set the protection of the setting value to off.
Or, a function that does not work is assigned to a function button. When the menu is not displayed, press the menu selection control to confirm the functions assigned to function buttons.
- **The black bars appear at the upper and lower or left and right positions of the display** → When the signal aspect ratio is different from that of the panel, the black bars appear. This is not a failure of the unit.
- **Adjustments and settings cannot be made** → Adjustments and settings may not be possible depending on the input signals and the status of the unit. See “Input Signals and Adjustable/Setting Items” (page 14).
- **The screen becomes dark and the unit turns off** → If the internal temperature of the unit increases, the screen may become dark and the unit may turn off. Check if the ventilation slots or vents are blocked with something such as dust.
In this case, refer to Sony qualified service personnel.
- **Color is not displayed correctly** → Check the [Interface Format] display or the [Signal Format], [Color Temp.], or [Color Space] setting.

Specifications

Picture performance

Panel	OLED panel
Picture size (diagonal)	750.2 mm (29 1/2 inches)
Effective picture size (H × V)	663.6 × 349.9 mm (26 1/4 × 13 7/8 inches)
Resolution (H × V)	4096 × 2160 pixels
Aspect	17:9
Pixel efficiency	99.99%
Panel drive	RGB 10-bit
Viewing angle (Panel specification)	89°/89°/89°/89° (typical) (up/down/left/right, contrast > 10:1)
Scan	0% scan (fixed)
Color temperature	D65, D93, D61, D55, DCI
Standard luminance (100% white signal input)	100 cd/m ² (User Preset1 – User Preset5) 48 cd/m ² (User Preset XYZ)
Warm-up time	Approx. 30 minutes To provide stable picture quality, turn on the power of the monitor and leave it in this state for more than 30 minutes.

Input

SDI 1 (3G/HD) input	BNC type (4) Input impedance: 75 Ω unbalanced
SDI 2 (3G/HD) input	BNC type (4) Input impedance: 75 Ω unbalanced
HDMI input	HDMI connector (1) HDCP 2.2
Serial remote (LAN)	RJ-45 modular connector (1) Ethernet (10BASE-T/100BASE-TX)

Output

MONITOR (3G/HD) output	BNC type (4) Output impedance: 75 Ω unbalanced
Audio monitor output connector	Stereo mini jack (1)
Headphones output connector	Stereo mini jack (1)

General

Power	AC 100 V to 240 V, 2.8 A to 1.2 A, 50/60 Hz
Power consumption	Approx. 280 W (max.) Approx. 150 W (average power consumption in the default status)
Inrush current	(1) Maximum possible inrush current at initial switch-on (Voltage changes caused by manual switching): 72 A peak, 7 A r.m.s. (240V AC) (2) Inrush current after a mains interruption of five seconds (Voltage changes caused at zero-crossing): 17 A peak, 3 A r.m.s. (240V AC)
Operating conditions	
Temperature	0 °C to 35 °C (32 °F to 95 °F)
Recommended temperature	20 °C to 30 °C (68 °F to 86 °F)
Humidity	30% to 85% (no condensation)
Pressure	700 hPa to 1060 hPa
Storage and transport conditions	
Temperature	-20 °C to +60 °C (-4 °F to +140 °F)
Humidity	0% to 90%
Pressure	700 hPa to 1060 hPa
Accessories supplied	AC power cord (1) AC plug holder (1) HDMI cable holder (1) Before Using This Unit (1) CD-ROM (1) European Representative (1)

Design and specifications are subject to change without notice.

Notes

- Always verify that the unit is operating properly before use. SONY WILL NOT BE LIABLE FOR DAMAGES OF ANY KIND INCLUDING, BUT NOT LIMITED TO, COMPENSATION OR REIMBURSEMENT ON ACCOUNT OF THE LOSS OF PRESENT OR PROSPECTIVE PROFITS DUE TO FAILURE OF THIS UNIT, EITHER DURING THE WARRANTY PERIOD OR AFTER EXPIRATION OF THE WARRANTY, OR FOR ANY OTHER REASON WHATSOEVER.
- SONY WILL NOT BE LIABLE FOR CLAIMS OF ANY KIND MADE BY USERS OF THIS UNIT OR MADE BY THIRD PARTIES.
- SONY WILL NOT BE LIABLE FOR THE TERMINATION OR DISCONTINUATION OF ANY SERVICES RELATED TO THIS UNIT THAT MAY RESULT DUE TO CIRCUMSTANCES OF ANY KIND.

SONY WILL NOT BE LIABLE FOR DAMAGES OF ANY KIND RESULTING FROM A FAILURE TO IMPLEMENT PROPER SECURITY MEASURES ON TRANSMISSION DEVICES, UNAVOIDABLE DATA LEAKS RESULTING FROM TRANSMISSION SPECIFICATIONS, OR SECURITY PROBLEMS OF ANY KIND.

Depending on the operating environment, unauthorized third parties on the network may be able to access the unit. When connecting the unit to the network, be sure to confirm that the network is protected securely.

Available Signal Formats

The unit is applicable to the following signal formats.

2K/HD (HD-SDI)

Signal System	Signal Structure	SDI 1	SDI 2
1920 × 1080/60I ¹⁾	4 : 2 : 2 (YCbCr) 10bit	○	○
1920 × 1080/50I	4 : 2 : 2 (YCbCr) 10bit	○	○
1920 × 1080/30P ¹⁾	4 : 2 : 2 (YCbCr) 10bit	○	○
1920 × 1080/30PsF ¹⁾	4 : 2 : 2 (YCbCr) 10bit	○	○
1920 × 1080/25P	4 : 2 : 2 (YCbCr) 10bit	○	○
1920 × 1080/25PsF	4 : 2 : 2 (YCbCr) 10bit	○	○
1920 × 1080/24P ¹⁾	4 : 2 : 2 (YCbCr) 10bit	○	○
1920 × 1080/24PsF ¹⁾	4 : 2 : 2 (YCbCr) 10bit	○	○
1280 × 720/60P ¹⁾	4 : 2 : 2 (YCbCr) 10bit	○	○

Signal System	Signal Structure	SDI 1	SDI 2
1280 × 720/50P	4 : 2 : 2 (YCbCr) 10bit	○	○
1280 × 720/30P ¹⁾	4 : 2 : 2 (YCbCr) 10bit	○	○
1280 × 720/25P	4 : 2 : 2 (YCbCr) 10bit	○	○
1280 × 720/24P ¹⁾	4 : 2 : 2 (YCbCr) 10bit	○	○
2048 × 1080/30P ¹⁾	4 : 2 : 2 (YCbCr) 10bit	○	○
2048 × 1080/30PsF ¹⁾	4 : 2 : 2 (YCbCr) 10bit	○	○
2048 × 1080/25P	4 : 2 : 2 (YCbCr) 10bit	○	○
2048 × 1080/25PsF	4 : 2 : 2 (YCbCr) 10bit	○	○
2048 × 1080/24P ¹⁾	4 : 2 : 2 (YCbCr) 10bit	○	○
2048 × 1080/24PsF ¹⁾	4 : 2 : 2 (YCbCr) 10bit	○	○

2K/HD (HD-SDI Dual Link)

Signal System	Signal Structure	SDI 1	SDI 2
1920 × 1080/60P ¹⁾	4 : 2 : 2 (YCbCr) 10bit	○	○
1920 × 1080/50P	4 : 2 : 2 (YCbCr) 10bit	○	○
1920 × 1080/60I ¹⁾	4 : 4 : 4 (RGB) 10bit	○	○
	4 : 4 : 4 (YCbCr) 10bit		
	4 : 4 : 4 (RGB) 12bit		
	4 : 4 : 4 (YCbCr) 12bit		
1920 × 1080/50I	4 : 4 : 4 (RGB) 10bit	○	○
	4 : 4 : 4 (YCbCr) 10bit		
	4 : 4 : 4 (RGB) 12bit		
	4 : 4 : 4 (YCbCr) 12bit		
1920 × 1080/30P ¹⁾	4 : 4 : 4 (RGB) 10bit	○	○
	4 : 4 : 4 (YCbCr) 10bit		
	4 : 4 : 4 (RGB) 12bit		
	4 : 4 : 4 (YCbCr) 12bit		
1920 × 1080/30PsF ¹⁾	4 : 4 : 4 (RGB) 10bit	○	○
	4 : 4 : 4 (YCbCr) 10bit		
	4 : 4 : 4 (RGB) 12bit		
	4 : 4 : 4 (YCbCr) 12bit		
1920 × 1080/25P	4 : 4 : 4 (RGB) 10bit	○	○
	4 : 4 : 4 (YCbCr) 10bit		
	4 : 4 : 4 (RGB) 12bit		
	4 : 4 : 4 (YCbCr) 12bit		
1920 × 1080/25PsF	4 : 4 : 4 (RGB) 10bit	○	○
	4 : 4 : 4 (YCbCr) 10bit		
	4 : 4 : 4 (RGB) 12bit		
	4 : 4 : 4 (YCbCr) 12bit		
1920 × 1080/24P ¹⁾	4 : 4 : 4 (RGB) 10bit	○	○
	4 : 4 : 4 (YCbCr) 10bit		
	4 : 4 : 4 (RGB) 12bit		
	4 : 4 : 4 (YCbCr) 12bit		

Signal System	Signal Structure	SDI 1	SDI 2
1920 × 1080/24PsF ¹⁾	4 : 4 : 4 (RGB) 10bit	○	○
	4 : 4 : 4 (YCbCr) 10bit		
	4 : 4 : 4 (RGB) 12bit		
	4 : 4 : 4 (YCbCr) 12bit		
2048 × 1080/60P ¹⁾	4 : 2 : 2 (YCbCr) 10bit	○	○
2048 × 1080/50P	4 : 2 : 2 (YCbCr) 10bit	○	○
2048 × 1080/48P ¹⁾	4 : 2 : 2 (YCbCr) 10bit	○	○
2048 × 1080/30P ¹⁾	4 : 4 : 4 (RGB) 10bit	○	○
	4 : 4 : 4 (YCbCr) 10bit		
	4 : 4 : 4 (RGB) 12bit		
	4 : 4 : 4 (YCbCr) 12bit		
2048 × 1080/30PsF ¹⁾	4 : 4 : 4 (RGB) 10bit	○	○
	4 : 4 : 4 (YCbCr) 10bit		
	4 : 4 : 4 (RGB) 12bit		
	4 : 4 : 4 (YCbCr) 12bit		
2048 × 1080/25P	4 : 4 : 4 (RGB) 10bit	○	○
	4 : 4 : 4 (YCbCr) 10bit		
	4 : 4 : 4 (RGB) 12bit		
	4 : 4 : 4 (YCbCr) 12bit		
2048 × 1080/25PsF	4 : 4 : 4 (RGB) 10bit	○	○
	4 : 4 : 4 (YCbCr) 10bit		
	4 : 4 : 4 (RGB) 12bit		
	4 : 4 : 4 (YCbCr) 12bit		
2048 × 1080/24P ¹⁾	4 : 4 : 4 (RGB) 10bit	○	○
	4 : 4 : 4 (YCbCr) 10bit		
	4 : 4 : 4 (RGB) 12bit		
	4 : 4 : 4 (YCbCr) 12bit		
2048 × 1080/24PsF ¹⁾	4 : 4 : 4 (RGB) 10bit	○	○
	4 : 4 : 4 (YCbCr) 10bit		
	4 : 4 : 4 (RGB) 12bit		
	4 : 4 : 4 (YCbCr) 12bit		
2048 × 1080/30P	4 : 4 : 4 (XYZ) 12bit	○	○
2048 × 1080/30PsF	4 : 4 : 4 (XYZ) 12bit	○	○
2048 × 1080/25P	4 : 4 : 4 (XYZ) 12bit	○	○
2048 × 1080/25PsF	4 : 4 : 4 (XYZ) 12bit	○	○
2048 × 1080/24P	4 : 4 : 4 (XYZ) 12bit	○	○
2048 × 1080/24PsF	4 : 4 : 4 (XYZ) 12bit	○	○

2K/HD (3G-SDI)

Signal System	Signal Structure	SDI 1	SDI 2
1920 × 1080/60P ¹⁾	4 : 2 : 2 (YCbCr) 10bit	○	○
1920 × 1080/50P	4 : 2 : 2 (YCbCr) 10bit	○	○

Signal System	Signal Structure		SDI 1	SDI 2
1920 × 1080/60I ¹⁾	4 : 4 : 4 (RGB) 10bit	Level A/Level B-DL	○	○
	4 : 4 : 4 (YCbCr) 10bit			
	4 : 4 : 4 (RGB) 12bit			
	4 : 4 : 4 (YCbCr) 12bit			
1920 × 1080/50I	4 : 4 : 4 (RGB) 10bit	Level A/Level B-DL	○	○
	4 : 4 : 4 (YCbCr) 10bit			
	4 : 4 : 4 (RGB) 12bit			
	4 : 4 : 4 (YCbCr) 12bit			
1920 × 1080/30P ¹⁾	4 : 4 : 4 (RGB) 10bit	Level A/Level B-DL	○	○
	4 : 4 : 4 (YCbCr) 10bit			
	4 : 4 : 4 (RGB) 12bit			
	4 : 4 : 4 (YCbCr) 12bit			
1920 × 1080/30PsF ¹⁾	4 : 4 : 4 (RGB) 10bit	Level A/Level B-DL	○	○
	4 : 4 : 4 (YCbCr) 10bit			
	4 : 4 : 4 (RGB) 12bit			
	4 : 4 : 4 (YCbCr) 12bit			
1920 × 1080/25P	4 : 4 : 4 (RGB) 10bit	Level A/Level B-DL	○	○
	4 : 4 : 4 (YCbCr) 10bit			
	4 : 4 : 4 (RGB) 12bit			
	4 : 4 : 4 (YCbCr) 12bit			
1920 × 1080/25PsF	4 : 4 : 4 (RGB) 10bit	Level A/Level B-DL	○	○
	4 : 4 : 4 (YCbCr) 10bit			
	4 : 4 : 4 (RGB) 12bit			
	4 : 4 : 4 (YCbCr) 12bit			
1920 × 1080/24P ¹⁾	4 : 4 : 4 (RGB) 10bit	Level A/Level B-DL	○	○
	4 : 4 : 4 (YCbCr) 10bit			
	4 : 4 : 4 (RGB) 12bit			
	4 : 4 : 4 (YCbCr) 12bit			
1920 × 1080/24PsF ¹⁾	4 : 4 : 4 (RGB) 10bit	Level A/Level B-DL	○	○
	4 : 4 : 4 (YCbCr) 10bit			
	4 : 4 : 4 (RGB) 12bit			
	4 : 4 : 4 (YCbCr) 12bit			
1280 × 720/60P ¹⁾	4 : 4 : 4 (RGB) 10bit	Level-A	○	○
	4 : 4 : 4 (YCbCr) 10bit			
1280 × 720/50P	4 : 4 : 4 (RGB) 10bit	Level-A	○	○
	4 : 4 : 4 (YCbCr) 10bit			
1280 × 720/30P ¹⁾	4 : 4 : 4 (RGB) 10bit	Level-A	○	○
	4 : 4 : 4 (YCbCr) 10bit			
1280 × 720/25P	4 : 4 : 4 (RGB) 10bit	Level-A	○	○
	4 : 4 : 4 (YCbCr) 10bit			
1280 × 720/24P ¹⁾	4 : 4 : 4 (RGB) 10bit	Level-A	○	○
	4 : 4 : 4 (YCbCr) 10bit			
2048 × 1080/60P ¹⁾	4 : 2 : 2 (YCbCr) 10bit	Level A/Level B-DL	○	○
2048 × 1080/50P	4 : 2 : 2 (YCbCr) 10bit	Level A/Level B-DL	○	○
2048 × 1080/48P ¹⁾	4 : 2 : 2 (YCbCr) 10bit	Level A/Level B-DL	○	○

Signal System	Signal Structure		SDI 1	SDI 2
2048 × 1080/30P ¹⁾	4 : 4 : 4 (RGB) 10bit	Level A/Level B-DL	○	○
	4 : 4 : 4 (YCbCr) 10bit			
	4 : 4 : 4 (RGB) 12bit			
	4 : 4 : 4 (YCbCr) 12bit			
2048 × 1080/30PsF ¹⁾	4 : 4 : 4 (RGB) 10bit	Level A/Level B-DL	○	○
	4 : 4 : 4 (YCbCr) 10bit			
	4 : 4 : 4 (RGB) 12bit			
	4 : 4 : 4 (YCbCr) 12bit			
2048 × 1080/25P	4 : 4 : 4 (RGB) 10bit	Level A/Level B-DL	○	○
	4 : 4 : 4 (YCbCr) 10bit			
	4 : 4 : 4 (RGB) 12bit			
	4 : 4 : 4 (YCbCr) 12bit			
2048 × 1080/25PsF	4 : 4 : 4 (RGB) 10bit	Level A/Level B-DL	○	○
	4 : 4 : 4 (YCbCr) 10bit			
	4 : 4 : 4 (RGB) 12bit			
	4 : 4 : 4 (YCbCr) 12bit			
2048 × 1080/24P ¹⁾	4 : 4 : 4 (RGB) 10bit	Level A/Level B-DL	○	○
	4 : 4 : 4 (YCbCr) 10bit			
	4 : 4 : 4 (RGB) 12bit			
	4 : 4 : 4 (YCbCr) 12bit			
2048 × 1080/24PsF ¹⁾	4 : 4 : 4 (RGB) 10bit	Level A/Level B-DL	○	○
	4 : 4 : 4 (YCbCr) 10bit			
	4 : 4 : 4 (RGB) 12bit			
	4 : 4 : 4 (YCbCr) 12bit			
2048 × 1080/30P	4 : 4 : 4 (XYZ) 12bit	Level A/Level B-DL	○	○
2048 × 1080/30PsF	4 : 4 : 4 (XYZ) 12bit	Level A/Level B-DL	○	○
2048 × 1080/25P	4 : 4 : 4 (XYZ) 12bit	Level A/Level B-DL	○	○
2048 × 1080/25PsF	4 : 4 : 4 (XYZ) 12bit	Level A/Level B-DL	○	○
2048 × 1080/24P	4 : 4 : 4 (XYZ) 12bit	Level A/Level B-DL	○	○
2048 × 1080/24PsF	4 : 4 : 4 (XYZ) 12bit	Level A/Level B-DL	○	○

2K/HD (3G-SDI Dual Link)

Signal System	Signal Structure		SDI 1	SDI 2
1920 × 1080/60P ¹⁾	4 : 4 : 4 (RGB) 10bit	Level A/Level B-DL	○	○
	4 : 4 : 4 (YCbCr) 10bit			
	4 : 4 : 4 (RGB) 12bit			
	4 : 4 : 4 (YCbCr) 12bit			
1920 × 1080/50P	4 : 4 : 4 (RGB) 10bit	Level A/Level B-DL	○	○
	4 : 4 : 4 (YCbCr) 10bit			
	4 : 4 : 4 (RGB) 12bit			
	4 : 4 : 4 (YCbCr) 12bit			
2048 × 1080/60P ¹⁾	4 : 4 : 4 (RGB) 10bit	Level A/Level B-DL	○	○
	4 : 4 : 4 (YCbCr) 10bit			
	4 : 4 : 4 (RGB) 12bit			
	4 : 4 : 4 (YCbCr) 12bit			

Signal System	Signal Structure			SDI 1	SDI 2
2048 × 1080/50P	4 : 4 : 4 (RGB)	10bit	Level A/Level B-DL	○	○
	4 : 4 : 4 (YCbCr)	10bit			
	4 : 4 : 4 (RGB)	12bit			
	4 : 4 : 4 (YCbCr)	12bit			
2048 × 1080/48P ¹⁾	4 : 4 : 4 (RGB)	10bit	Level A/Level B-DL	○	○
	4 : 4 : 4 (YCbCr)	10bit			
	4 : 4 : 4 (RGB)	12bit			
	4 : 4 : 4 (YCbCr)	12bit			

4K/UHD (HD-SDI Quad Link)

Signal System	Signal Structure			SDI 1	SDI 2
3840 × 2160/30P ¹⁾	4 : 2 : 2 (YCbCr)	10bit	Square	○	○
3840 × 2160/30PsF ¹⁾	4 : 2 : 2 (YCbCr)	10bit	Square	○	○
3840 × 2160/25P	4 : 2 : 2 (YCbCr)	10bit	Square	○	○
3840 × 2160/25PsF	4 : 2 : 2 (YCbCr)	10bit	Square	○	○
3840 × 2160/24P ¹⁾	4 : 2 : 2 (YCbCr)	10bit	Square	○	○
3840 × 2160/24PsF ¹⁾	4 : 2 : 2 (YCbCr)	10bit	Square	○	○
4096 × 2160/30P ¹⁾	4 : 2 : 2 (YCbCr)	10bit	Square	○	○
4096 × 2160/30PsF ¹⁾	4 : 2 : 2 (YCbCr)	10bit	Square	○	○
4096 × 2160/25P	4 : 2 : 2 (YCbCr)	10bit	Square	○	○
4096 × 2160/25PsF	4 : 2 : 2 (YCbCr)	10bit	Square	○	○
4096 × 2160/24P ¹⁾	4 : 2 : 2 (YCbCr)	10bit	Square	○	○
4096 × 2160/24PsF ¹⁾	4 : 2 : 2 (YCbCr)	10bit	Square	○	○

4K/UHD (3G-SDI Dual Link)

Signal System	Signal Structure			SDI 1	SDI 2
3840 × 2160/30P ¹⁾	4 : 2 : 2 (YCbCr)	10bit	Level B-DS ²⁾ Square/2SI	○	○
3840 × 2160/30PsF ¹⁾	4 : 2 : 2 (YCbCr)	10bit	Level B-DS ²⁾ Square	○	○
3840 × 2160/25P	4 : 2 : 2 (YCbCr)	10bit	Level B-DS ²⁾ Square/2SI	○	○
3840 × 2160/25PsF	4 : 2 : 2 (YCbCr)	10bit	Level B-DS ²⁾ Square	○	○
3840 × 2160/24P ¹⁾	4 : 2 : 2 (YCbCr)	10bit	Level B-DS ²⁾ Square/2SI	○	○
3840 × 2160/24PsF ¹⁾	4 : 2 : 2 (YCbCr)	10bit	Level B-DS ²⁾ Square	○	○
4096 × 2160/30P ¹⁾	4 : 2 : 2 (YCbCr)	10bit	Level B-DS ²⁾ Square/2SI	○	○
4096 × 2160/30PsF ¹⁾	4 : 2 : 2 (YCbCr)	10bit	Level B-DS ²⁾ Square	○	○
4096 × 2160/25P	4 : 2 : 2 (YCbCr)	10bit	Level B-DS ²⁾ Square/2SI	○	○
4096 × 2160/25PsF	4 : 2 : 2 (YCbCr)	10bit	Level B-DS ²⁾ Square	○	○
4096 × 2160/24P ¹⁾	4 : 2 : 2 (YCbCr)	10bit	Level B-DS ²⁾ Square/2SI	○	○
4096 × 2160/24PsF ¹⁾	4 : 2 : 2 (YCbCr)	10bit	Level B-DS ²⁾ Square	○	○

4K/UHD (3G-SDI Quad Link)

Signal System	Signal Structure			SDI 1	SDI 2
3840 × 2160/60P ¹⁾	4 : 2 : 2 (YCbCr)	10bit	Level A/Level B-DL Square/2SI	○	○
3840 × 2160/50P	4 : 2 : 2 (YCbCr)	10bit	Level A/Level B-DL Square/2SI	○	○

Signal System	Signal Structure			SDI 1	SDI 2
3840 × 2160/30P ¹⁾	4 : 4 : 4 (RGB)	10bit	Level A/Level B-DL	Square/2SI	○
	4 : 4 : 4 (YCbCr)	10bit			
	4 : 4 : 4 (RGB)	12bit			
	4 : 4 : 4 (YCbCr)	12bit			
3840 × 2160/30PsF ¹⁾	4 : 4 : 4 (RGB)	10bit	Level A/Level B-DL	Square	○
	4 : 4 : 4 (YCbCr)	10bit			
	4 : 4 : 4 (RGB)	12bit			
	4 : 4 : 4 (YCbCr)	12bit			
3840 × 2160/25P	4 : 4 : 4 (RGB)	10bit	Level A/Level B-DL	Square/2SI	○
	4 : 4 : 4 (YCbCr)	10bit			
	4 : 4 : 4 (RGB)	12bit			
	4 : 4 : 4 (YCbCr)	12bit			
3840 × 2160/25PsF	4 : 4 : 4 (RGB)	10bit	Level A/Level B-DL	Square	○
	4 : 4 : 4 (YCbCr)	10bit			
	4 : 4 : 4 (RGB)	12bit			
	4 : 4 : 4 (YCbCr)	12bit			
3840 × 2160/24P ¹⁾	4 : 4 : 4 (RGB)	10bit	Level A/Level B-DL	Square/2SI	○
	4 : 4 : 4 (YCbCr)	10bit			
	4 : 4 : 4 (RGB)	12bit			
	4 : 4 : 4 (YCbCr)	12bit			
3840 × 2160/24PsF ¹⁾	4 : 4 : 4 (RGB)	10bit	Level A/Level B-DL	Square	○
	4 : 4 : 4 (YCbCr)	10bit			
	4 : 4 : 4 (RGB)	12bit			
	4 : 4 : 4 (YCbCr)	12bit			
4096 × 2160/60P ¹⁾	4 : 2 : 2 (YCbCr)	10bit	Level A/Level B-DL	Square/2SI	○
4096 × 2160/50P	4 : 2 : 2 (YCbCr)	10bit	Level A/Level B-DL	Square/2SI	○
4096 × 2160/48P ¹⁾	4 : 2 : 2 (YCbCr)	10bit	Level A/Level B-DL	Square/2SI	○
4096 × 2160/30P ¹⁾	4 : 4 : 4 (RGB)	10bit	Level A/Level B-DL	Square/2SI	○
	4 : 4 : 4 (YCbCr)	10bit			
	4 : 4 : 4 (RGB)	12bit			
	4 : 4 : 4 (YCbCr)	12bit			
4096 × 2160/30PsF ¹⁾	4 : 4 : 4 (RGB)	10bit	Level A/Level B-DL	Square	○
	4 : 4 : 4 (YCbCr)	10bit			
	4 : 4 : 4 (RGB)	12bit			
	4 : 4 : 4 (YCbCr)	12bit			
4096 × 2160/25P	4 : 4 : 4 (RGB)	10bit	Level A/Level B-DL	Square/2SI	○
	4 : 4 : 4 (YCbCr)	10bit			
	4 : 4 : 4 (RGB)	12bit			
	4 : 4 : 4 (YCbCr)	12bit			
4096 × 2160/25PsF	4 : 4 : 4 (RGB)	10bit	Level A/Level B-DL	Square	○
	4 : 4 : 4 (YCbCr)	10bit			
	4 : 4 : 4 (RGB)	12bit			
	4 : 4 : 4 (YCbCr)	12bit			

Signal System	Signal Structure			SDI 1	SDI 2
4096 × 2160/24P ¹⁾	4 : 4 : 4 (RGB) 10bit	Level A/Level B-DL	Square/2SI	○	○
	4 : 4 : 4 (YCbCr) 10bit				
	4 : 4 : 4 (RGB) 12bit				
	4 : 4 : 4 (YCbCr) 12bit				
4096 × 2160/24PsF ¹⁾	4 : 4 : 4 (RGB) 10bit	Level A/Level B-DL	Square	○	○
	4 : 4 : 4 (YCbCr) 10bit				
	4 : 4 : 4 (RGB) 12bit				
	4 : 4 : 4 (YCbCr) 12bit				
4096 × 2160/30P	4 : 4 : 4 (XYZ) 12bit	Level A/Level B-DL	Square/2SI	○	○
4096 × 2160/30PsF	4 : 4 : 4 (XYZ) 12bit	Level A/Level B-DL	Square	○	○
4096 × 2160/25P	4 : 4 : 4 (XYZ) 12bit	Level A/Level B-DL	Square/2SI	○	○
4096 × 2160/25PsF	4 : 4 : 4 (XYZ) 12bit	Level A/Level B-DL	Square	○	○
4096 × 2160/24P	4 : 4 : 4 (XYZ) 12bit	Level A/Level B-DL	Square/2SI	○	○
4096 × 2160/24PsF	4 : 4 : 4 (XYZ) 12bit	Level A/Level B-DL	Square	○	○

1) Also compatible with 1/1.001.

2) When Square is selected (physically same when 2SI is selected).

HDMI

Signal System	Signal Structure	HDMI
640 × 480/60P ¹⁾	4 : 4 : 4 (RGB) 12/10/8bit	○
	4 : 4 : 4 (YCbCr) 12/10/8bit	
	4 : 2 : 2 (YCbCr) 12bit	
720 × 480/60P ¹⁾	4 : 4 : 4 (RGB) 12/10/8bit	○
	4 : 4 : 4 (YCbCr) 12/10/8bit	
	4 : 2 : 2 (YCbCr) 12bit	
1280 × 720/60P ¹⁾	4 : 4 : 4 (RGB) 12/10/8bit	○
	4 : 4 : 4 (YCbCr) 12/10/8bit	
	4 : 2 : 2 (YCbCr) 12bit	
1920 × 1080/60I ¹⁾	4 : 4 : 4 (RGB) 12/10/8bit	○
	4 : 4 : 4 (YCbCr) 12/10/8bit	
	4 : 2 : 2 (YCbCr) 12bit	
720 × 576/50P	4 : 4 : 4 (RGB) 12/10/8bit	○
	4 : 4 : 4 (YCbCr) 12/10/8bit	
	4 : 2 : 2 (YCbCr) 12bit	
1280 × 720/50P	4 : 4 : 4 (RGB) 12/10/8bit	○
	4 : 4 : 4 (YCbCr) 12/10/8bit	
	4 : 2 : 2 (YCbCr) 12bit	
1920 × 1080/50I	4 : 4 : 4 (RGB) 12/10/8bit	○
	4 : 4 : 4 (YCbCr) 12/10/8bit	
	4 : 2 : 2 (YCbCr) 12bit	
1920 × 1080/60P ¹⁾	4 : 4 : 4 (RGB) 12/10/8bit	○
	4 : 4 : 4 (YCbCr) 12/10/8bit	
	4 : 2 : 2 (YCbCr) 12bit	

Signal System	Signal Structure	HDMI
1920 × 1080/50P	4 : 4 : 4 (RGB) 12/10/8bit	○
	4 : 4 : 4 (YCbCr) 12/10/8bit	
	4 : 2 : 2 (YCbCr) 12bit	
1920 × 1080/30P ¹⁾	4 : 4 : 4 (RGB) 12/10/8bit	○
	4 : 4 : 4 (YCbCr) 12/10/8bit	
	4 : 2 : 2 (YCbCr) 12bit	
1920 × 1080/25P	4 : 4 : 4 (RGB) 12/10/8bit	○
	4 : 4 : 4 (YCbCr) 12/10/8bit	
	4 : 2 : 2 (YCbCr) 12bit	
1920 × 1080/24P ¹⁾	4 : 4 : 4 (RGB) 12/10/8bit	○
	4 : 4 : 4 (YCbCr) 12/10/8bit	
	4 : 2 : 2 (YCbCr) 12bit	
2048 × 1080/60P ¹⁾	4 : 4 : 4 (RGB) 12/10/8bit	○
	4 : 4 : 4 (YCbCr) 12/10/8bit	
	4 : 2 : 2 (YCbCr) 12bit	
2048 × 1080/50P	4 : 4 : 4 (RGB) 12/10/8bit	○
	4 : 4 : 4 (YCbCr) 12/10/8bit	
	4 : 2 : 2 (YCbCr) 12bit	
2048 × 1080/48P	4 : 4 : 4 (RGB) 12/10/8bit	○
	4 : 4 : 4 (YCbCr) 12/10/8bit	
	4 : 2 : 2 (YCbCr) 12bit	
2048 × 1080/30P ¹⁾	4 : 4 : 4 (RGB) 12/10/8bit	○
	4 : 4 : 4 (YCbCr) 12/10/8bit	
	4 : 2 : 2 (YCbCr) 12bit	
2048 × 1080/25P	4 : 4 : 4 (RGB) 12/10/8bit	○
	4 : 4 : 4 (YCbCr) 12/10/8bit	
	4 : 2 : 2 (YCbCr) 12bit	
2048 × 1080/24P ¹⁾	4 : 4 : 4 (RGB) 12/10/8bit	○
	4 : 4 : 4 (YCbCr) 12/10/8bit	
	4 : 2 : 2 (YCbCr) 12bit	
3840 × 2160/30P ^{1) 2)}	4 : 4 : 4 (RGB) 12/10/8bit ^{3) 5)}	○
	4 : 4 : 4 (YCbCr) 12/10/8bit ^{3) 4)}	
	4 : 2 : 2 (YCbCr) 12bit	
3840 × 2160/25P ²⁾	4 : 4 : 4 (RGB) 12/10/8bit ^{3) 5)}	○
	4 : 4 : 4 (YCbCr) 12/10/8bit ^{3) 4)}	
	4 : 2 : 2 (YCbCr) 12bit	
3840 × 2160/24P ^{1) 2)}	4 : 4 : 4 (RGB) 12/10/8bit ^{3) 5)}	○
	4 : 4 : 4 (YCbCr) 12/10/8bit ^{3) 4)}	
	4 : 2 : 2 (YCbCr) 12bit	
4096 × 2160/30P ^{1) 2)}	4 : 4 : 4 (RGB) 12/10/8bit ^{3) 5)}	○
	4 : 4 : 4 (YCbCr) 12/10/8bit ^{3) 4)}	
	4 : 2 : 2 (YCbCr) 12bit	
4096 × 2160/25P ²⁾	4 : 4 : 4 (RGB) 12/10/8bit ^{3) 5)}	○
	4 : 4 : 4 (YCbCr) 12/10/8bit ^{3) 4)}	
	4 : 2 : 2 (YCbCr) 12bit	

Signal System	Signal Structure	HDMI
4096 × 2160/24P ^{1) 2)}	4 : 4 : 4 (RGB) 12/10/8bit ^{3) 5)}	○
	4 : 4 : 4 (YCbCr) 12/10/8bit ^{3) 4)}	
	4 : 2 : 2 (YCbCr) 12bit	
3840 × 2160/60P ^{1) 2)}	4 : 4 : 4 (RGB) 8bit ³⁾	○
	4 : 4 : 4 (YCbCr) 8bit ³⁾	
	4 : 2 : 2 (YCbCr) 12bit ³⁾	
	4 : 2 : 0 (YCbCr) 8bit	
3840 × 2160/50P ²⁾	4 : 4 : 4 (RGB) 8bit ³⁾	○
	4 : 4 : 4 (YCbCr) 8bit ³⁾	
	4 : 2 : 2 (YCbCr) 12bit ³⁾	
	4 : 2 : 0 (YCbCr) 8bit	
4096 × 2160/60P ^{1) 2)}	4 : 4 : 4 (RGB) 8bit ³⁾	○
	4 : 4 : 4 (YCbCr) 8bit ³⁾	
	4 : 2 : 2 (YCbCr) 12bit ³⁾	
	4 : 2 : 0 (YCbCr) 8bit	
4096 × 2160/50P ²⁾	4 : 4 : 4 (RGB) 8bit ³⁾	○
	4 : 4 : 4 (YCbCr) 8bit ³⁾	
	4 : 2 : 2 (YCbCr) 12bit ³⁾	
	4 : 2 : 0 (YCbCr) 8bit	
800 × 600/60P	4 : 4 : 4 (RGB) 12/10/8bit	○
	4 : 4 : 4 (YCbCr) 12/10/8bit	
	4 : 2 : 2 (YCbCr) 12bit	
1024 × 768/60P	4 : 4 : 4 (RGB) 12/10/8bit	○
	4 : 4 : 4 (YCbCr) 12/10/8bit	
	4 : 2 : 2 (YCbCr) 12bit	

1) Also compatible with the frame rate 1/1.001.

2) This signal is described as “equivalent to the 4K signal” in this manual.

3) [Enhanced Format] must be selected in the [HDMI Signal Format] menu (page 30). Also, when using this input signal, use the Premium High-Speed HDMI cable. (30P, 25P, 24P signals are only for the 4:4:4 RGB/YCbCr 10/12bit signal.)

4) The 4:4:4(YCbCr)12/10bit signal is displayed after converting to the 4:2:2(YCbCr)12/10bit signal.

5) The 4:4:4(RGB)12/10bit signal is displayed after converting to the 4:2:2(YCbCr)12/10bit signal or is displayed as a 4:4:4(RGB)8bit signal.

Dimensions

Front

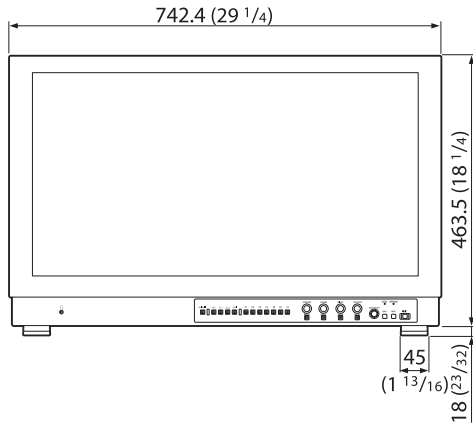

Rear

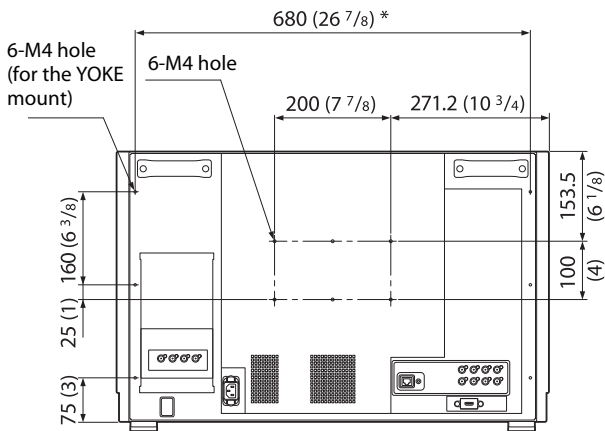

To install on a vehicle, fix the unit using screw holes for the YOKE mount.

* is the reference value.

Side

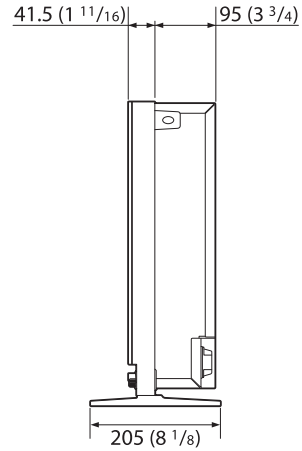

Unit: mm (inches)

Mass:

Approx. 16.2 kg (35 lb 12 oz)

* Length of M4 screws (rear)

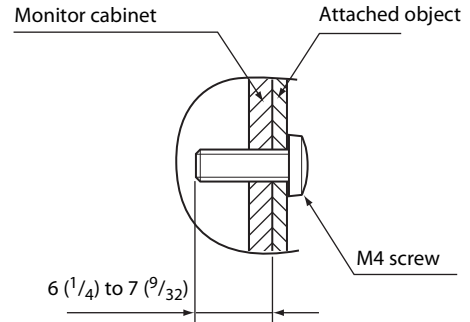

Unit: mm (inches)

